

HighSpeed 2-Technology

- **Designed for:**
 - SMPS
 - Lamp Ballast
 - ZVS-Converter
 - optimised for soft-switching / resonant topologies
- **2nd generation HighSpeed-Technology for 1200V applications offers:**
 - loss reduction in resonant circuits
 - temperature stable behavior
 - parallel switching capability
 - tight parameter distribution
 - E_{off} optimized for $I_C = 1A$

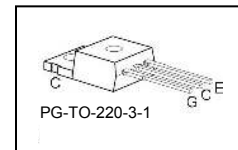
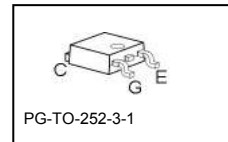
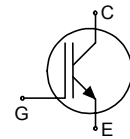

- Qualified according to JEDEC² for target applications
- Pb-free lead plating; RoHS compliant
- Complete product spectrum and PSpice Models : <http://www.infineon.com/igbt/>

Type	V_{CE}	I_C	E_{off}	T_j	Marking	Package
IGP01N120H2	1200V	1A	0.09mJ	150°C	G01H1202	PG-TO-220-3-1
IGD01N120H2	1200V	1A	0.09mJ	150°C	G1H1202	PG-TO-252-3-11

Maximum Ratings

Parameter	Symbol	Value	Unit
Collector-emitter voltage	V_{CE}	1200	V
Triangular collector current	I_C		A
$T_C = 25^\circ\text{C}, f = 140\text{kHz}$		3.2	
$T_C = 100^\circ\text{C}, f = 140\text{kHz}$		1.3	
Pulsed collector current, t_p limited by T_{jmax}	I_{Cpuls}	3.5	
Turn off safe operating area	-	3.5	
$V_{CE} \leq 1200\text{V}, T_j \leq 150^\circ\text{C}$			
Gate-emitter voltage	V_{GE}	± 20	V
Power dissipation	P_{tot}	28	W
$T_C = 25^\circ\text{C}$			
Operating junction and storage temperature	T_j, T_{stg}	-40...+150	°C
Soldering temperature	-		
PG-TO-252: Reflow soldering, MSL3		260	
Others: wavesoldering, 1.6 mm (0.063 in.) from case for 10s		260	

² J-STD-020 and JESD-022

Thermal Resistance

Parameter	Symbol	Conditions	Max. Value	Unit
Characteristic				
IGBT thermal resistance, junction – case	R_{thJC}		4.5	K/W
Thermal resistance, junction – ambient	R_{thJA}	PG-TO-220-3-1	62	
SMD version, device on PCB ¹⁾	R_{thJA}	PG-TO-252-3-1	50	

Electrical Characteristic, at $T_j = 25^\circ\text{C}$, unless otherwise specified

Parameter	Symbol	Conditions	Value			Unit	
			min.	Typ.	max.		
Static Characteristic							
Collector-emitter breakdown voltage	$V_{(BR)CES}$	$V_{GE}=0V, I_C=300\mu A$	1200	-	-	V	
Collector-emitter saturation voltage	$V_{CE(sat)}$	$V_{GE} = 15V, I_C=1A$ $T_j=25^\circ\text{C}$ $T_j=150^\circ\text{C}$	-	2.2	2.8		
			$V_{GE} = 10V, I_C=1A,$ $T_j=25^\circ\text{C}$	-	2.5		-
				-	2.4		-
Gate-emitter threshold voltage	$V_{GE(th)}$	$I_C=30\mu A, V_{CE}=V_{GE}$	2.1	3	3.9		
Zero gate voltage collector current	I_{CES}	$V_{CE}=1200V, V_{GE}=0V$ $T_j=25^\circ\text{C}$ $T_j=150^\circ\text{C}$	-	-	20	μA	
			-	-	80		
Gate-emitter leakage current	I_{GES}	$V_{CE}=0V, V_{GE}=20V$	-	-	40	nA	
Transconductance	g_{fs}	$V_{CE}=20V, I_C=1A$	-	0.75	-	S	
Dynamic Characteristic							
Input capacitance	C_{iss}	$V_{CE}=25V,$ $V_{GE}=0V,$ $f=1\text{MHz}$	-	91.6	-	pF	
Output capacitance	C_{oss}		-	9.8	-		
Reverse transfer capacitance	C_{rss}		-	3.4	-		
Gate charge	Q_{Gate}	$V_{CC}=960V, I_C=1A$ $V_{GE}=15V$	-	8.6	-	nC	
Internal emitter inductance measured 5mm (0.197 in.) from case	L_E		-	7	-	nH	

¹⁾ Device on 50mm*50mm*1.5mm epoxy PCB FR4 with 6cm² (one layer, 70μm thick) copper area for collector connection. PCB is vertical without blown air.

Switching Characteristic, Inductive Load, at $T_j=25^\circ\text{C}$

Parameter	Symbol	Conditions	Value			Unit
			min.	Typ.	max.	
IGBT Characteristic						
Turn-on delay time	$t_{d(on)}$	$T_j=25^\circ\text{C}$, $V_{CC}=800\text{V}$, $I_C=1\text{A}$, $V_{GE}=15\text{V}/0\text{V}$, $R_G=241\Omega$, $L_\sigma^{2)}=180\text{nH}$, $C_\sigma^{2)}=40\text{pF}$ Energy losses include "tail" and diode ³⁾ reverse recovery.	-	13	-	ns
Rise time	t_r		-	6.3	-	
Turn-off delay time	$t_{d(off)}$		-	370	-	
Fall time	t_f		-	28	-	
Turn-on energy	E_{on}		-	0.08	-	mJ
Turn-off energy	E_{off}		-	0.06	-	
Total switching energy	E_{ts}		-	0.14	-	

Switching Characteristic, Inductive Load, at $T_j=150^\circ\text{C}$

Parameter	Symbol	Conditions	Value			Unit
			min.	Typ.	max.	
IGBT Characteristic						
Turn-on delay time	$t_{d(on)}$	$T_j=150^\circ\text{C}$ $V_{CC}=800\text{V}$, $I_C=1\text{A}$, $V_{GE}=15\text{V}/0\text{V}$, $R_G=241\Omega$, $L_\sigma^{2)}=180\text{nH}$, $C_\sigma^{2)}=40\text{pF}$ Energy losses include "tail" and diode ⁴⁾ reverse recovery.	-	12	-	ns
Rise time	t_r		-	8.9	-	
Turn-off delay time	$t_{d(off)}$		-	450	-	
Fall time	t_f		-	43	-	
Turn-on energy	E_{on}		-	0.11	-	mJ
Turn-off energy	E_{off}		-	0.09	-	
Total switching energy	E_{ts}		-	0.2	-	

Switching Energy ZVT, Inductive Load

Parameter	Symbol	Conditions	Value			Unit
			min.	Typ.	max.	
IGBT Characteristic						
Turn-off energy	E_{off}	$V_{CC}=800\text{V}$, $I_C=1\text{A}$, $V_{GE}=15\text{V}/0\text{V}$, $R_G=241\Omega$, $C_r^{2)}=1\text{nF}$ $T_j=25^\circ\text{C}$ $T_j=150^\circ\text{C}$	-	0.02 0.044	-	mJ
			-		-	

²⁾ Leakage inductance L_σ and stray capacity C_σ due to dynamic test circuit in figure E

⁴⁾ Commutation diode from device IKP01N120H2

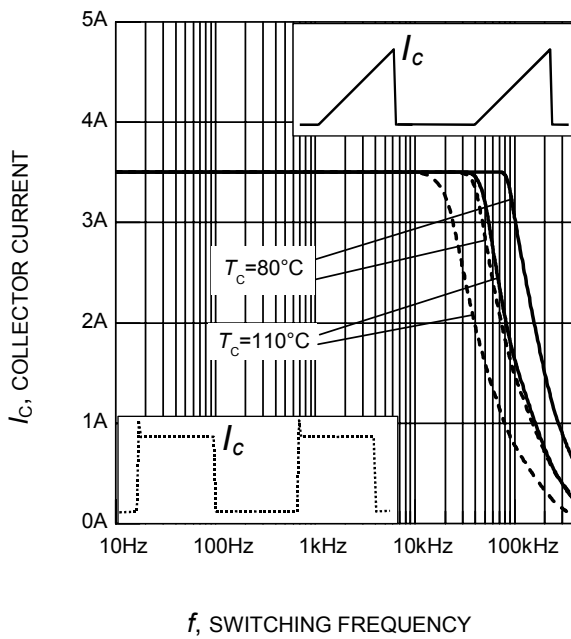

Figure 1. Collector current as a function of switching frequency
($T_j \leq 150^\circ\text{C}$, $D = 0.5$, $V_{CE} = 800\text{V}$, $V_{GE} = +15\text{V}/0\text{V}$, $R_G = 241\Omega$)

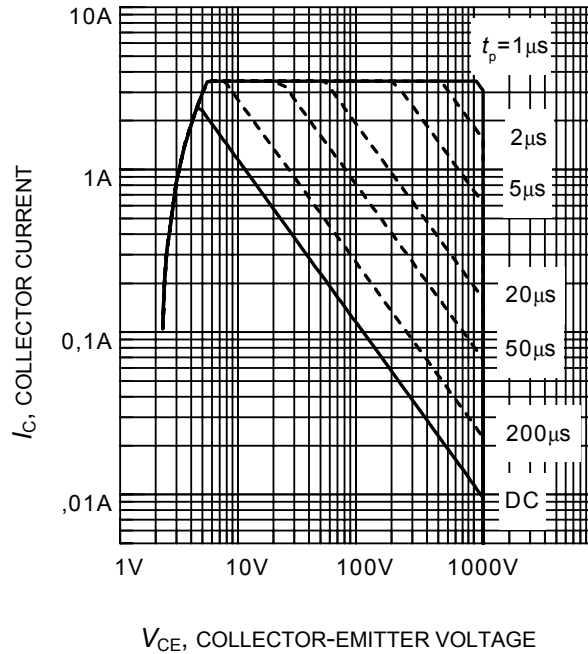

Figure 2. Safe operating area
($D = 0$, $T_C = 25^\circ\text{C}$, $T_j \leq 150^\circ\text{C}$)

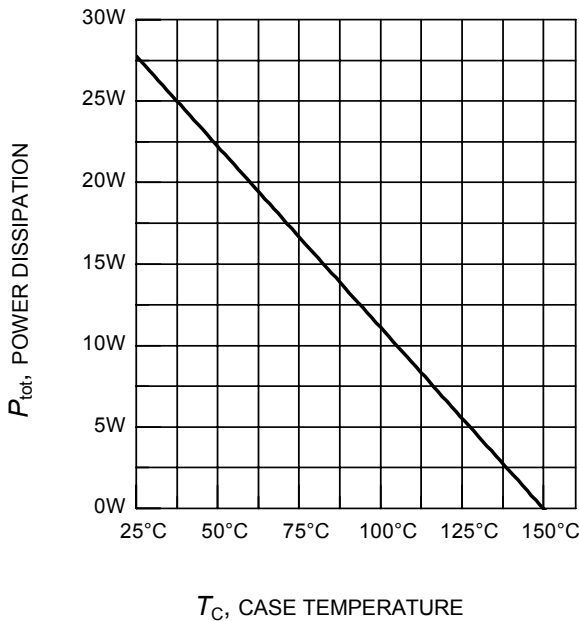

Figure 3. Power dissipation as a function of case temperature
($T_j \leq 150^\circ\text{C}$)

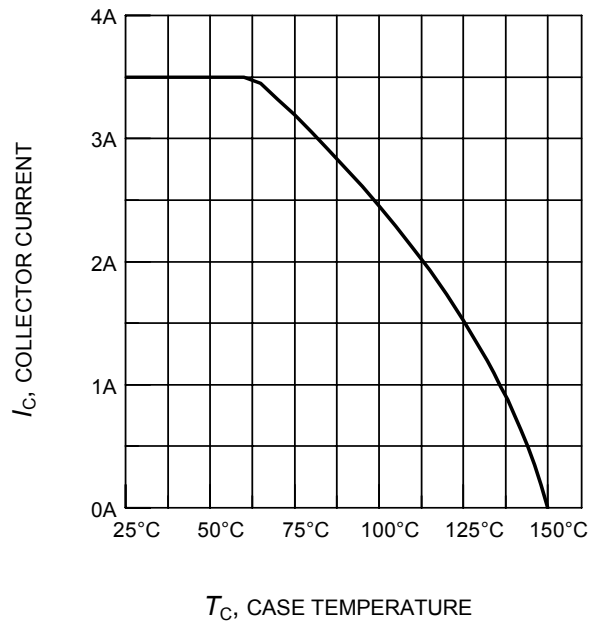
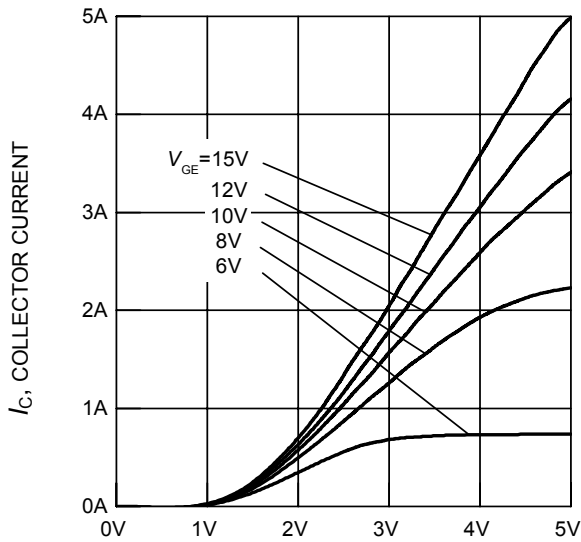
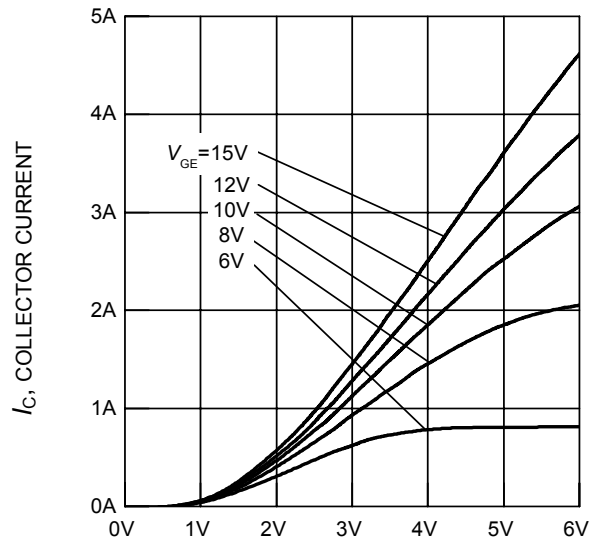

Figure 4. Collector current as a function of case temperature
($V_{GE} \leq 15\text{V}$, $T_j \leq 150^\circ\text{C}$)



V_{CE} , COLLECTOR-EMITTER VOLTAGE

Figure 5. Typical output characteristics
($T_j = 25^\circ\text{C}$)



V_{CE} , COLLECTOR-EMITTER VOLTAGE

Figure 6. Typical output characteristics
($T_j = 150^\circ\text{C}$)

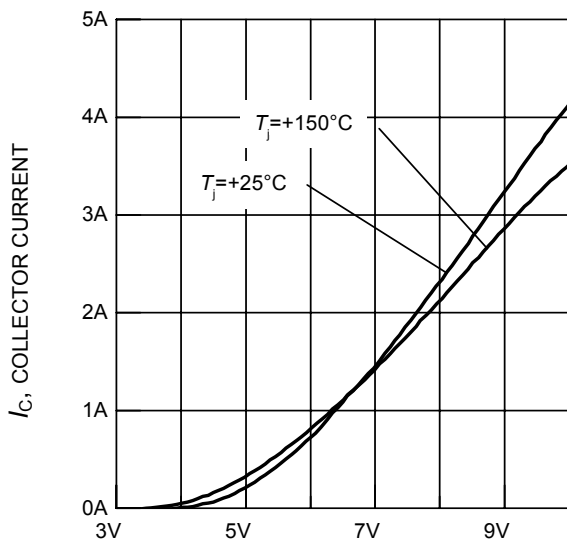

V_{GE} , GATE-EMITTER VOLTAGE

Figure 7. Typical transfer characteristics
($V_{CE} = 20\text{V}$)

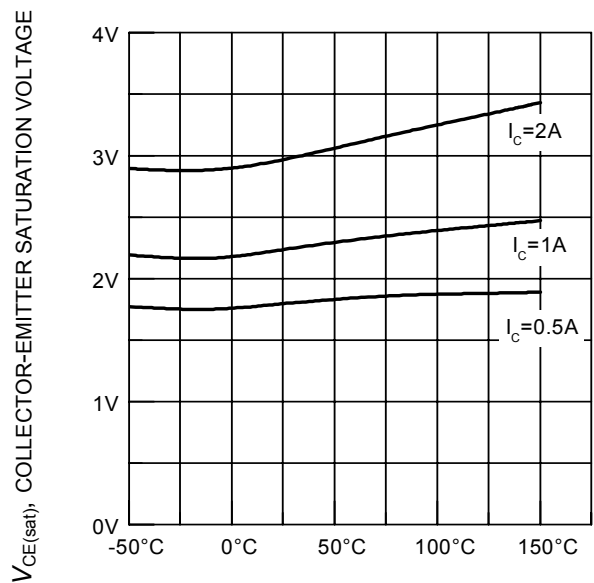

T_j , JUNCTION TEMPERATURE

Figure 8. Typical collector-emitter saturation voltage as a function of junction temperature
($V_{GE} = 15\text{V}$)

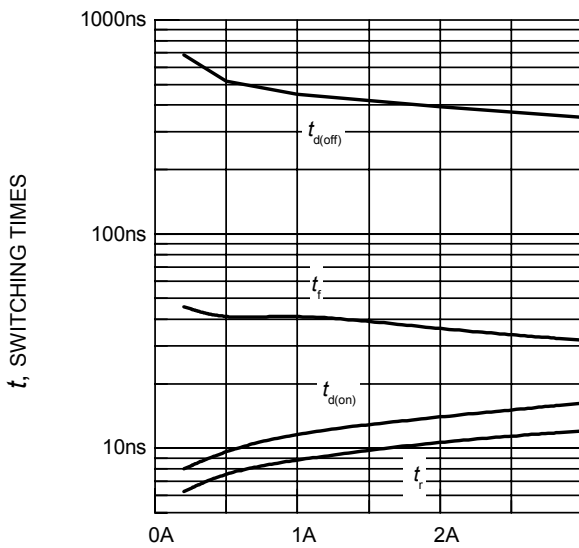

I_C , COLLECTOR CURRENT

Figure 9. Typical switching times as a function of collector current

(inductive load, $T_j = 150^\circ\text{C}$,
 $V_{CE} = 800\text{V}$, $V_{GE} = +15\text{V}/0\text{V}$, $R_G = 241\Omega$,
dynamic test circuit in Fig.E)

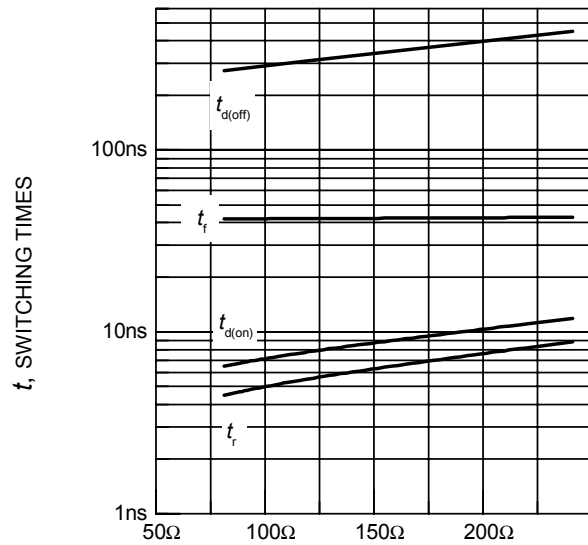

R_G , GATE RESISTOR

Figure 10. Typical switching times as a function of gate resistor

(inductive load, $T_j = 150^\circ\text{C}$,
 $V_{CE} = 800\text{V}$, $V_{GE} = +15\text{V}/0\text{V}$, $I_C = 1\text{A}$,
dynamic test circuit in Fig.E)

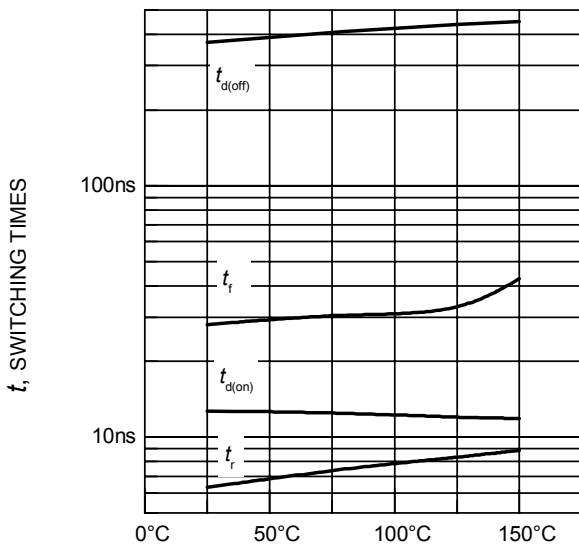

T_j , JUNCTION TEMPERATURE

Figure 11. Typical switching times as a function of junction temperature

(inductive load, $V_{CE} = 800\text{V}$,
 $V_{GE} = +15\text{V}/0\text{V}$, $I_C = 1\text{A}$, $R_G = 241\Omega$,
dynamic test circuit in Fig.E)

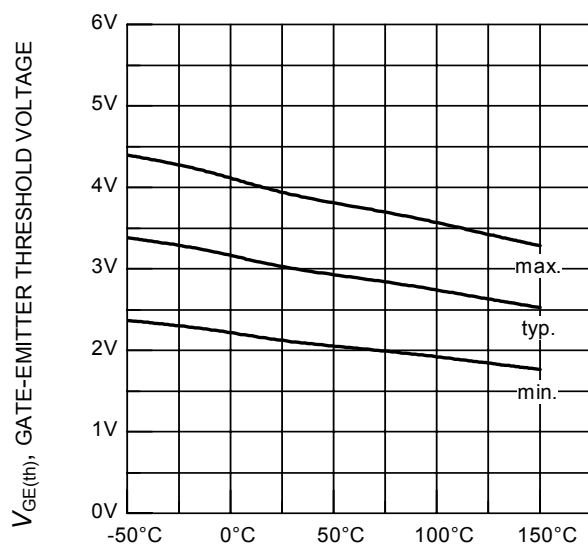

T_j , JUNCTION TEMPERATURE

Figure 12. Gate-emitter threshold voltage as a function of junction temperature

($I_C = 0.03\text{mA}$)

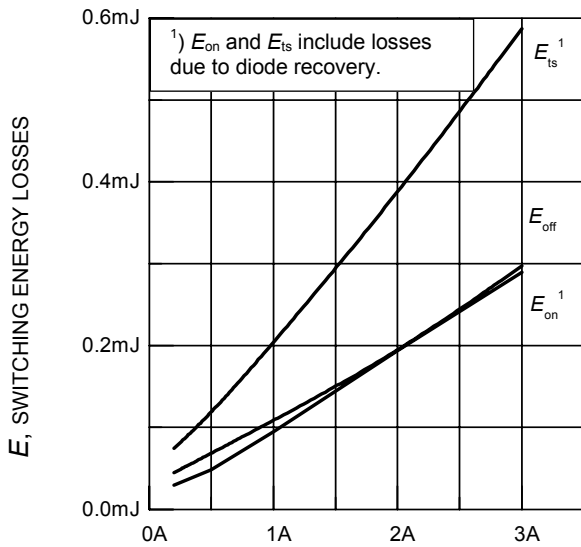

I_C , COLLECTOR CURRENT

Figure 13. Typical switching energy losses as a function of collector current

(inductive load, $T_j = 150^\circ\text{C}$, $V_{CE} = 800\text{V}$, $V_{GE} = +15\text{V}/0\text{V}$, $R_G = 241\Omega$, dynamic test circuit in Fig.E)

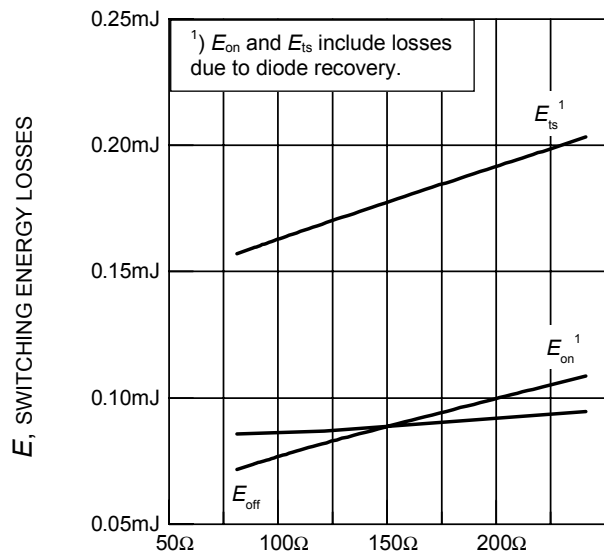

R_G , GATE RESISTOR

Figure 14. Typical switching energy losses as a function of gate resistor

(inductive load, $T_j = 150^\circ\text{C}$, $V_{CE} = 800\text{V}$, $V_{GE} = +15\text{V}/0\text{V}$, $I_C = 1\text{A}$, dynamic test circuit in Fig.E)

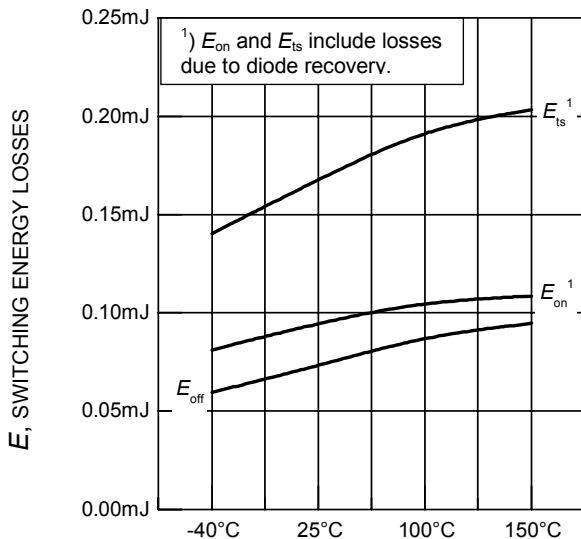

T_j , JUNCTION TEMPERATURE

Figure 15. Typical switching energy losses as a function of junction temperature

(inductive load, $V_{CE} = 800\text{V}$, $V_{GE} = +15\text{V}/0\text{V}$, $I_C = 1\text{A}$, $R_G = 241\Omega$, dynamic test circuit in Fig.E)

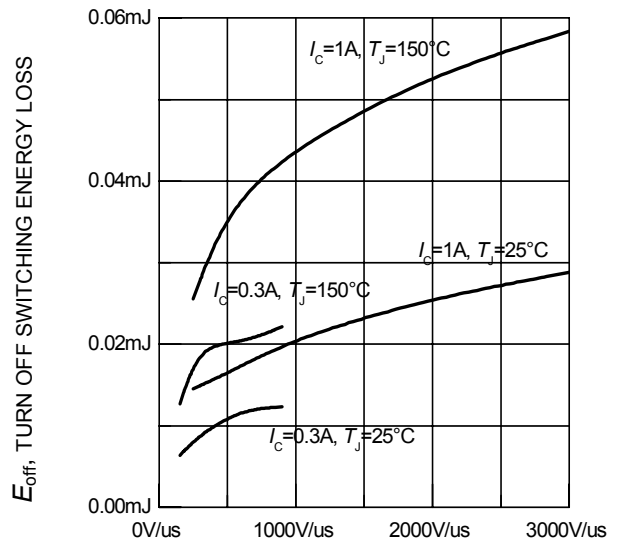

dv/dt , VOLTAGE SLOPE

Figure 16. Typical turn off switching energy loss for soft switching

(dynamic test circuit in Fig. E)

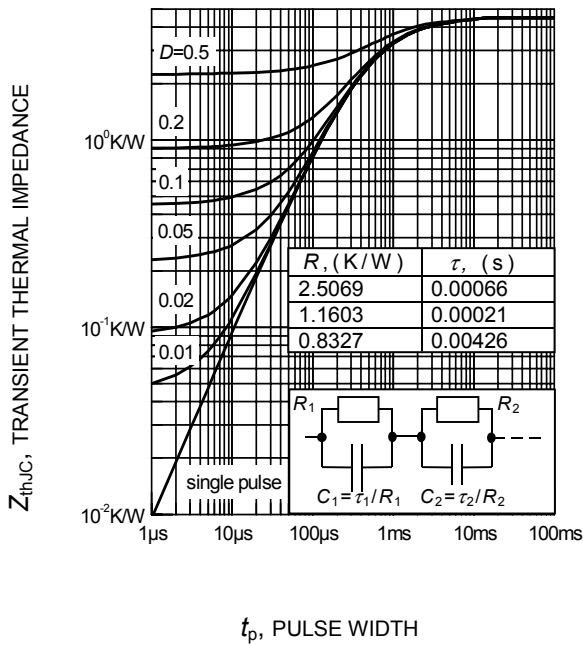

Figure 17. IGBT transient thermal impedance as a function of pulse width
($D = t_p / T$)

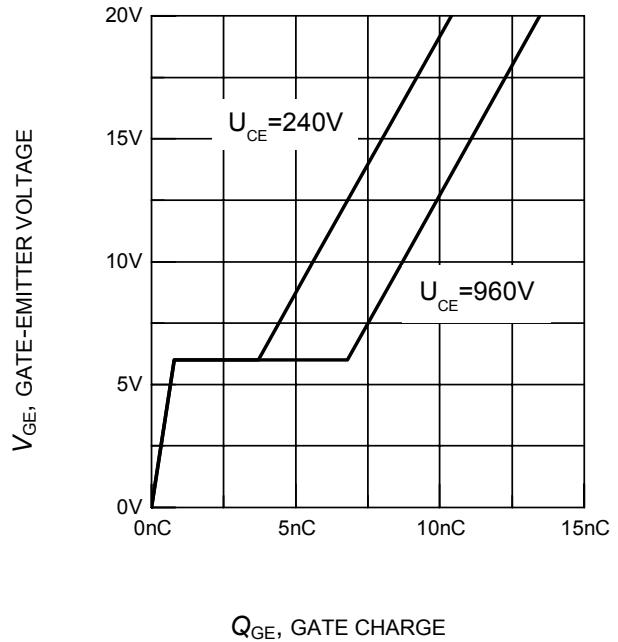

Figure 18. Typical gate charge
($I_C = 1A$)

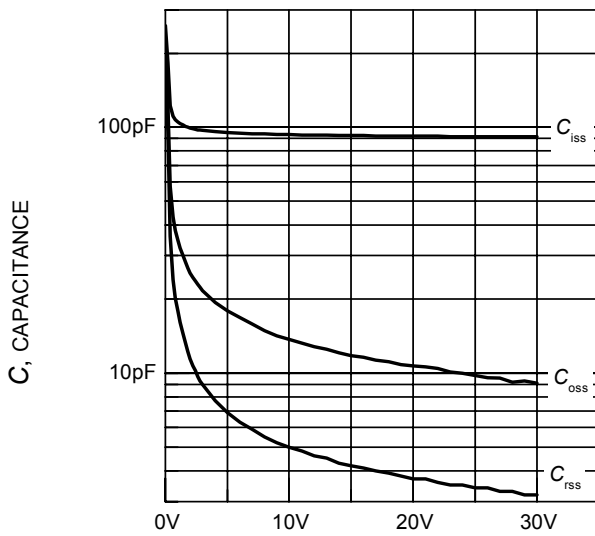

Figure 19. Typical capacitance as a function of collector-emitter voltage
($V_{GE} = 0V, f = 1MHz$)

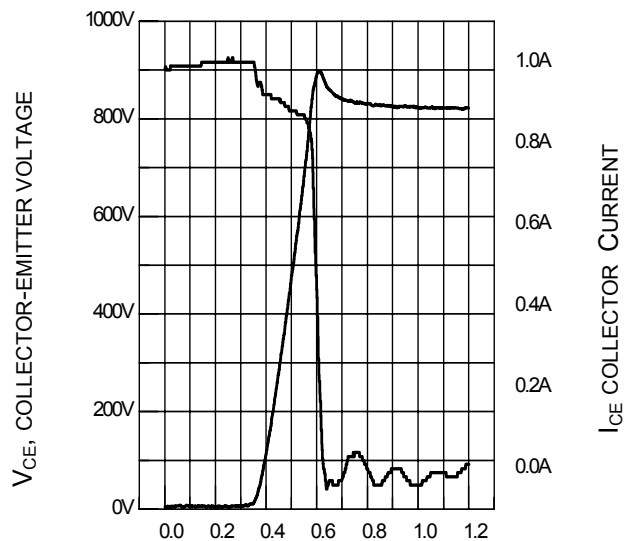

Figure 20. Typical turn off behavior, hard switching
($V_{GE} = 15/0V, R_G = 220\Omega, T_j = 150^\circ C,$
Dynamic test circuit in Figure E)

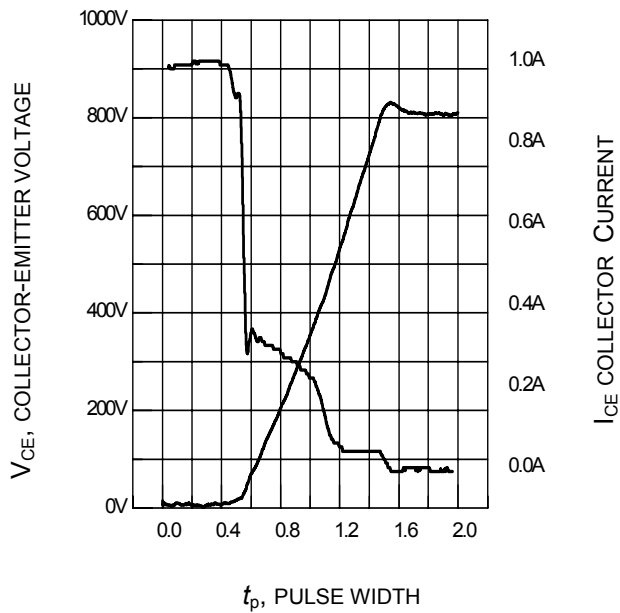
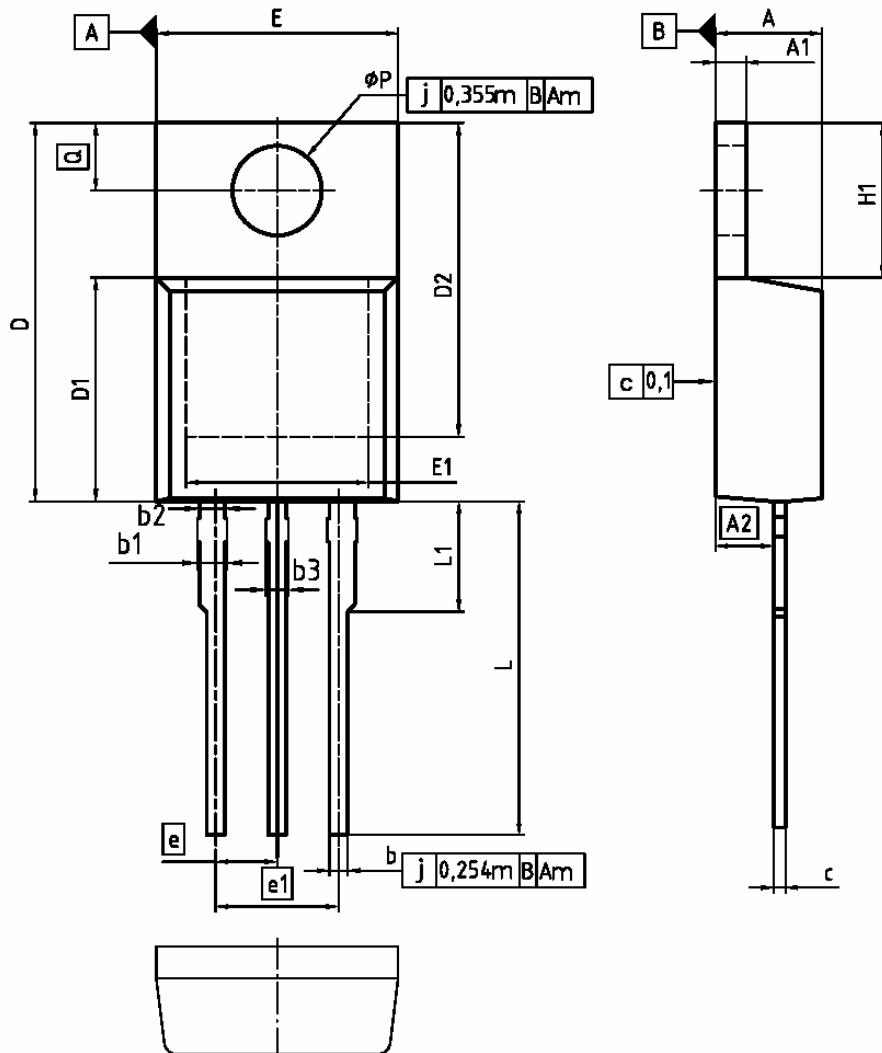

Figure 21. Typical turn off behavior, soft switching

($V_{GE}=15/0V$, $R_G=220\Omega$, $T_j = 150^\circ C$,
Dynamic test circuit in Figure E)

PG-TO220-3-1



DIM	MILLIMETERS		INCHES	
	MIN	MAX	MIN	MAX
A	4.30	4.57	0.169	0.180
A1	1.17	1.40	0.046	0.055
A2	2.15	2.72	0.085	0.107
b	0.65	0.86	0.026	0.034
b1	0.95	1.40	0.037	0.055
b2	0.95	1.15	0.037	0.045
b3	0.85	1.15	0.028	0.045
c	0.33	0.80	0.013	0.024
D	14.81	15.95	0.583	0.628
D1	8.51	9.45	0.335	0.372
D2	12.19	13.10	0.480	0.516
E	9.70	10.36	0.382	0.408
E1	6.50	8.60	0.256	0.339
e	2.54		0.100	
e1	5.08		0.200	
N	3		3	
H1	5.90	6.90	0.232	0.272
L	13.00	14.00	0.512	0.551
L1	-	4.80	-	0.189
phi P	3.60	3.80	0.142	0.153
Q	2.60	3.00	0.102	0.118

DOCUMENT NO.
Z8B00003318

SCALE

EUROPEAN PROJECTION

ISSUE DATE
23-08-2007

REVISION
05

P-TO252-3-11

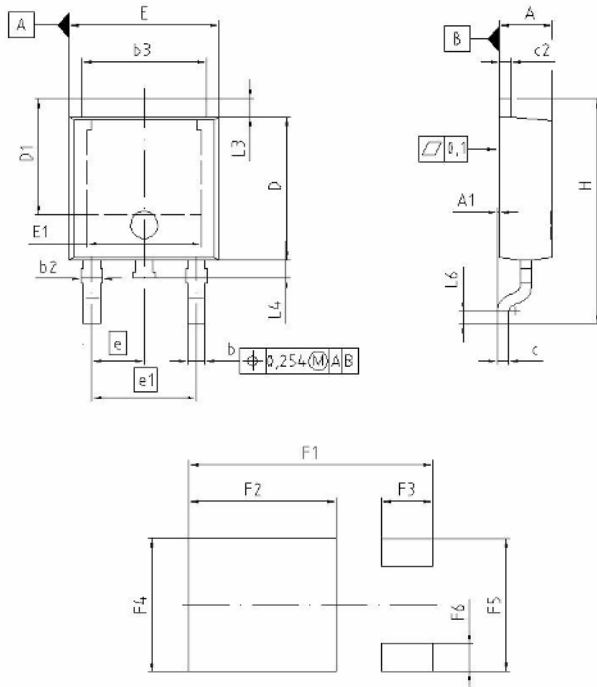

DIM	MILLIMETERS		INCHES	
	MIN	MAX	MIN	MAX
A	2.184	2.388	0.086	0.094
A1	0.000	0.150	0.000	0.006
b	0.635	0.889	0.025	0.035
b2	0.650	1.150	0.025	0.045
b3	5.004	5.500	0.197	0.217
c	0.460	0.580	0.018	0.023
c2	0.460	0.980	0.018	0.039
D	5.969	6.223	0.235	0.245
D1	5.020	5.320	0.198	0.209
E	6.400	6.731	0.252	0.265
E1	4.900	5.100	0.193	0.201
e	2.286		0.090	
e1	4.572		0.180	
N	3		3	
H	9.400	10.084	0.370	0.397
L3	0.900	1.118	0.035	0.044
L4	0.650	1.016	0.026	0.040
L6	0.510	0.686	0.020	0.027
F1	10.500	10.700	0.413	0.421
F2	6.300	6.500	0.248	0.256
F3	2.100	2.300	0.083	0.091
F4	5.700	5.900	0.224	0.232
F5	5.860	5.860	0.222	0.231
F6	1.100	1.300	0.043	0.051

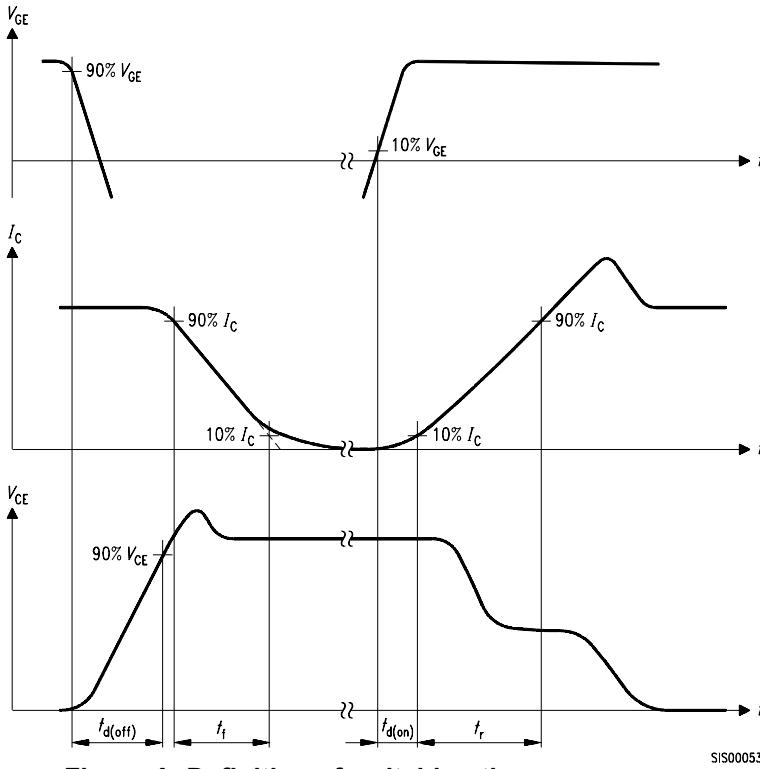

Figure A. Definition of switching times

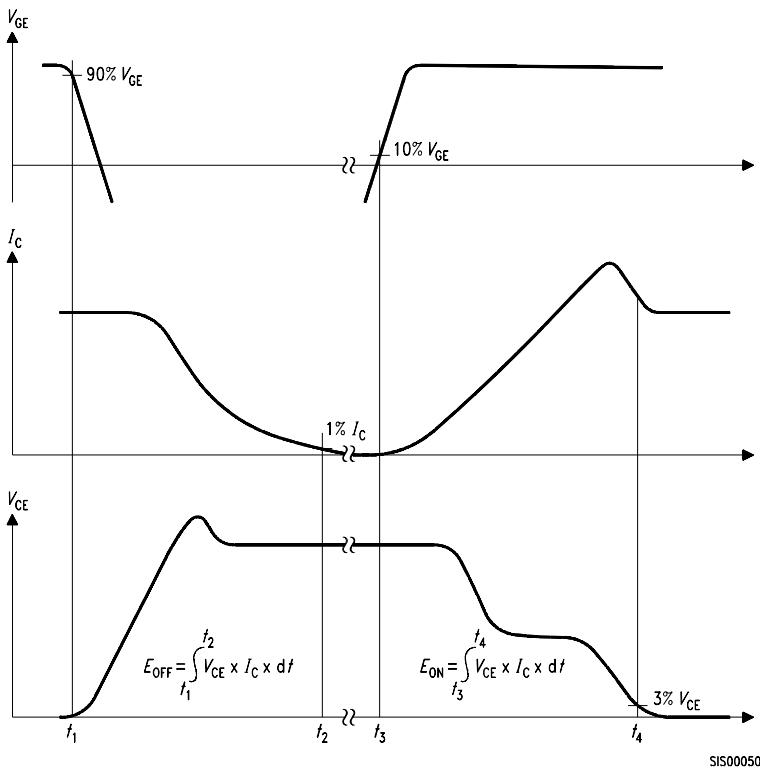

Figure B. Definition of switching losses

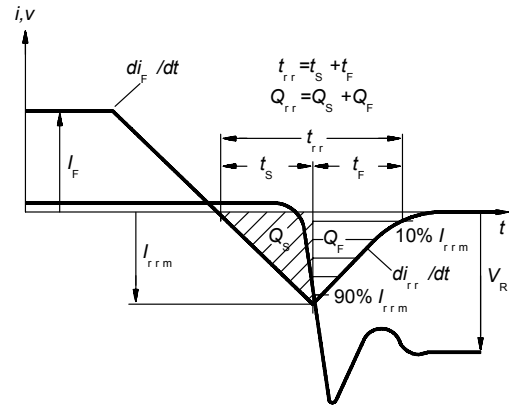

Figure C. Definition of diodes switching characteristics

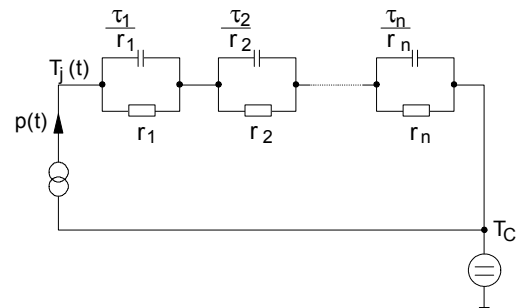

Figure D. Thermal equivalent circuit

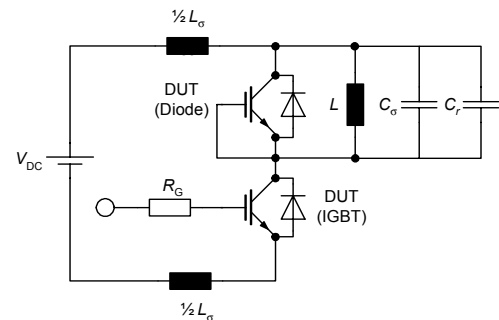

Figure E. Dynamic test circuit
Leakage inductance $L_{\sigma} = 180\text{nH}$,
Stray capacitor $C_{\sigma} = 40\text{pF}$,
Relief capacitor $C_r = 1\text{nF}$ (only for ZVT switching)

Edition 2006-01

Published by
Infineon Technologies AG
81726 München, Germany

© Infineon Technologies AG 9/13/07.

All Rights Reserved.

Attention please!

The information given in this data sheet shall in no event be regarded as a guarantee of conditions or characteristics ("Beschaffenheitsgarantie"). With respect to any examples or hints given herein, any typical values stated herein and/or any information regarding the application of the device, Infineon Technologies hereby disclaims any and all warranties and liabilities of any kind, including without limitation warranties of non-infringement of intellectual property rights of any third party.

Information

For further information on technology, delivery terms and conditions and prices please contact your nearest Infineon Technologies Office (www.infineon.com).

Warnings

Due to technical requirements components may contain dangerous substances. For information on the types in question please contact your nearest Infineon Technologies Office.

Infineon Technologies Components may only be used in life-support devices or systems with the express written approval of Infineon Technologies, if a failure of such components can reasonably be expected to cause the failure of that life-support device or system, or to affect the safety or effectiveness of that device or system. Life support devices or systems are intended to be implanted in the human body, or to support and/or maintain and sustain and/or protect human life. If they fail, it is reasonable to assume that the health of the user or other persons may be endangered.