

ACHL-7241 and ACHL-7242

Fully Integrated, Hall Effect-Based Linear Current Sensor IC with 5-kV_{RMS} Isolation and Low-Resistance Current Conductor

Description

The Broadcom[®] ACHL-7241 and ACHL-7242 ($\pm 10\text{A}$ and $\pm 20\text{A}$) fully integrated Hall Effect-based isolated linear current sensors are designed for AC or DC current sensing in industrial, commercial, and communications systems. Inside each of the ACHL-7241 and ACHL-7242 IC is a precise, low-offset, linear Hall circuit with a copper conduction path located near the surface of the die. Applied current flowing through this copper conduction path generates a magnetic field that the Hall sensors convert into a proportional voltage. Device accuracy is optimized through the close proximity of the magnetic signal to the Hall sensors.

A precise, proportional voltage is provided by the low-offset, chopper-stabilized CMOS Hall IC, which is programmed for accuracy after packaging. The output of the device has a positive slope ($>V_{OUT(Q)}$) when an increasing current flows through the primary copper conduction path (from pins 1, 2, and 3, to pins 4, 5, and 6), which is the path used for current sampling.

The internal resistance of this conductive path is 0.6 m Ω typical, providing low power loss. The terminals of the conductive path are electrically isolated from the signal leads (pins 7 through 12). This performance is delivered in a compact, surface mountable Stretched SO-12 package that meets worldwide regulatory safety standards.

Part Number	Sensing Range	Sensitivity	Rated Current
ACHL-7241	$\pm 10\text{ Apk}$	200 mV/A	10ADC
ACHL-7242	$\pm 20\text{ Apk}$	100 mV/A	20ADC

Features

- Wide operating temperature: -40°C to $+110^{\circ}\text{C}$
- Internal conductor resistance: 0.6 m Ω typ.
- Sensing current range: $\pm 10\text{A}$ and $\pm 20\text{A}$
- Output sensitivity: 200 mV/A and 100 mV/A
- Output voltage proportional to AC or DC currents
- Ratiometric output from supply voltage
- Single supply operation: 5.0V
- Low-noise analog signal path
- Device bandwidth is set using the new FILTER pin
 - 80-kHz typ. bandwidth with 1-nF filter capacitor
- Factory-trimmed for accuracy
- Extremely stable output offset voltage
- Near-zero magnetic hysteresis
- Maximum output error of $\pm 5.5\%$ across operating T_a
- $>25\text{ kV}/\mu\text{s}$ common-mode transient immunity
- Small-footprint Stretched SO-12 package
- Worldwide safety approval: UL/cUL, IEC/EN62368-1
 - Isolation Voltage: 5 kVrms 1 minute

Applications

- Sewing machines
- Welder
- E-bikes
- Street lighting
- Low-power inverter current sensing
- Motor phase and rail current sensing
- Solar inverters
- Chargers and converters
- Switching power supplies

CAUTION! Take normal static precautions in handling and assembly of this component to prevent damage, degradation, or both, that may be induced by ESD. The components featured in this data sheet are not to be used in military or aerospace applications or environments.

Functional Diagram

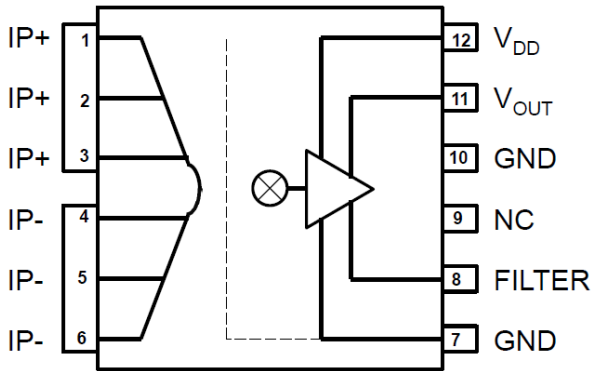

NOTE: The connection of 1- μ F bypass capacitor between pins 12 and 7 (and 10) is recommended.

Pin Description

Pin	Pin Name	Description
1	I _{P+}	Terminals for current being sampled; fused internally
2	I _{P+}	
3	I _{P+}	
4	I _{P-}	Terminals for current being sampled; fused internally
5	I _{P-}	
6	I _{P-}	

Pin	Pin Name	Description
12	V _{DD}	Supply Voltage relative to GND
11	V _{OUT}	Output Voltage
10	GND	Output-side Ground
9	nc	Not Connected
8	FILTER	Filter Pin to set Bandwidth
7	GND	Output-side Ground

Typical Application Circuit

A typical application circuit for the ACHL-7241 or ACHL-7242 requires a 1- μ F bypass capacitor and a filter capacitor as additional external components. On the input side, pin 1, pin 2, and pin 3 are shorted together, and pin 4, pin 5, and pin 6 are shorted together. The output voltage is measured directly from the V_{OUT} pin.

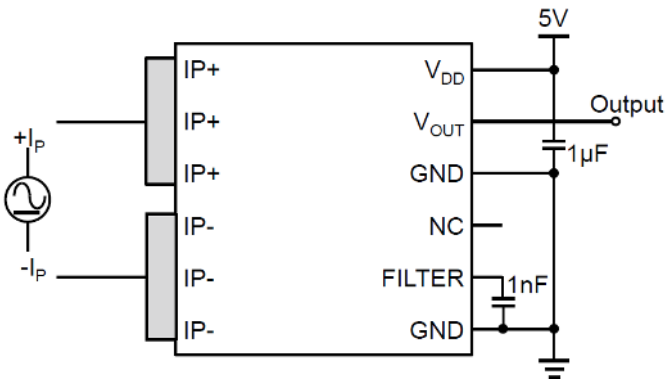

Ordering Information

Part Number	Current Range	Option	Package	Surface Mount	Tape and Reel	UL 5 kV _{RMS} 1 min. rating	Quantity
		(RoHS Compliant)					
ACHL-7241	±10A	-000E	SSO-12	X		X	80 per tube
		-500E		X	X	X	1000 per reel
ACHL-7242	±20A	-000E		X		X	80 per tube
		-500E		X	X	X	1000 per reel

To form an order entry, choose a part number from the Part Number column and combine with the desired option from the option column.

Example:

Select ACHL-7242-500E to order product with ±20A, Surface Mount type in Tape-and-Reel packaging and RoHS compliance. Contact your Broadcom sales representative or authorized distributor for information.

Option data sheets are available. Contact your Broadcom sales representative or authorized distributor for information.

Package Outline Drawing (to be updated)

ACHL-7241 and ACHL-7242 SSO-12 12 Lead Surface Mount Package

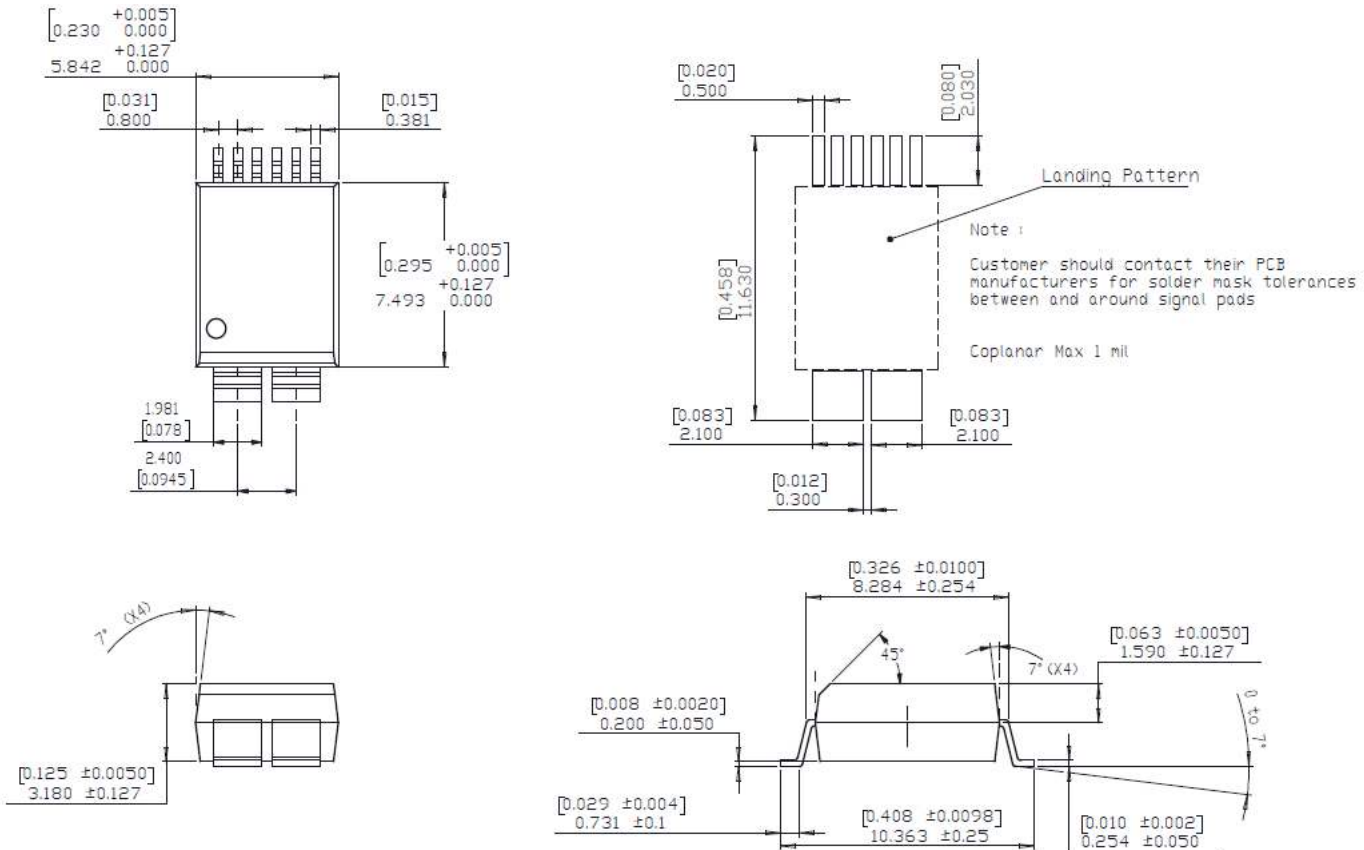

NOTE:

1. Dimensions are in millimeters (inches).
2. Lead Co-planarity = 0.100 mm (0.004 in.) maximum.
3. Floating lead protrusion = 0.254 mm (0.010 in.) maximum.
4. Mold flash on each side = 0.127 mm (0.005 in.) maximum.

Recommended Pb-Free IR Profile

Recommended reflow condition as per JEDEC Standard, J-STD-020 (latest revision). Non-halide flux should be used.

Regulatory Information

The ACHL-7241 and ACHL-7242 ICs are approved by the following organizations:

- UL/cUL approval: UL 1577, component recognition program up to $V_{ISO} = 5000 V_{RMS}$.
- Approved under IEC/EN 62368-1 (former IEC 60950-1).

Insulation and Safety Related Specifications

Parameter	Symbol	Value	Unit	Conditions
Minimum External Air Gap (External Clearance)	L(101)	8.3	mm	Measured from input terminals to output terminals, shortest distance through air
Minimum External Tracking (External Creepage)	L(102)	8.5	mm	Measured from input terminals to output terminals, shortest distance path along body
Minimum Internal Plastic Gap (Internal Clearance)	—	0.05	mm	Through insulation distance, conductor to conductor, usually the direct distance between the primary input conductor and the detector IC
Tracking Resistance (Comparative Tracking Index)	CTI	>175	V	DIN IEC 112/VDE 0303 Part 1
Isolation Group	—	IIIa	—	Material Group (DIN VDE 0110, 1/89, Table 1)

Absolute Maximum Rating

Parameter	Symbol	Min.	Max.	Unit	Test Conditions
Storage Temperature	T _S	-55	+150	°C	—
Ambient Operating Temperature	T _A	-40	+110	°C	—
Junction Temperature	T _{J(max)}	—	+150	°C	—
Primary Conductor Lead Temperature	T _{L(max)}	—	+150	°C	Pins 1, 2, 3, 4, 5, or 6
Supply Voltages	V _{DD}	-0.5	8.0	V	—
Output Voltage	V _{OUT}	-0.5	V _{DD} + 0.5	V	—
Output Current Source	I _{OUT(source)}	—	10	mA	T _A = 25°C
Output Current Sink	I _{OUT(sink)}	—	10	mA	T _A = 25°C
Overcurrent Transient Tolerance	I _P	—	100	A	1 pulse, 100 ms, T _A = 25°C
Input Power Dissipation	P _{IN}	—	1500	mW	—
Output Power Dissipation	P _{OUT}	—	90	mW	—

Recommended Operating Conditions

Parameter	Symbol	Min.	Max.	Unit	
Ambient Operating Temperature	T _A	-40	+110	°C	
VDD Supply Voltage	V _{DD}	4.5	5.5	V	
Output Capacitance Load	C _{LOAD}	—	10	nF	
Output Resistive Load	R _{LOAD}	4.7	—	kΩ	
Input Peak Current Range	ACHL-7241	I _{pk}	-10	+10	A
	ACHL-7242		-20	+20	A

Common Electrical Specifications

Unless otherwise stated, all minimum/maximum specifications are over recommended operating conditions. All typical values are based on $T_A = +25^\circ\text{C}$, $V_{DD} = 5.0\text{V}$, $C_F = 1\text{nF}$.

Parameter	Symbol	Min.	Typ.	Max.	Unit	Test Condition	Figure	Note
Supply Current	I_{DD}	—	13	15	mA	$V_{DD} = 5\text{V}$, output open	6	—
Primary Conductance Resistance	$R_{PRIMARY}$	—	0.6	—	m Ω	—	—	—
Zero Current Output Voltage	$V_{OUT(Q)}$	—	$V_{DD} / 2$	—	V	Bidirectional, $I_P = 0\text{A}$	—	—
Input Filter Resistance	$R_{F(INT)}$	—	1.6	—	k Ω	—	—	—
Rise Time (20% to 80%)	t_r	—	3	—	μs	$C_L = 100\text{ pF}$	10	a
Fall Time (80% to 20%)	t_f	—	3	—	μs	$C_L = 100\text{ pF}$	12	a
Rise Response Time (80% \leftrightarrow 80%)	t_{rr}	—	5	—	μs	$C_L = 100\text{ pF}$	9	a
Fall Response Time (20% \leftrightarrow 20%)	t_{fr}	—	5	—	μs	$C_L = 100\text{ pF}$	11	a
Power-on Time	t_{PO}	—	20	—	μs	—	8	a
Common-Mode Transient Immunity	CMTI	25	—	—	kV/ μs	$V_{CM} = 1000\text{V}$	—	b

a. See [Definition of Electrical Characteristics](#).

b. Common Mode Transient Immunity is tested by applying a fast rising/falling voltage pulse across pin 1-6 and GND (pin 7). The output glitch observed is less than 0.2V from the average output voltage for less than 1 μs .

Electrical Specifications

ACHL-7241

Unless otherwise stated, all minimum/maximum specifications are obtained over recommended operating conditions. All typical values are based on $T_A = +25^\circ\text{C}$, $V_{DD} = 5.0\text{V}$, $C_F = 1\text{ nF}$.

Parameter	Symbol	Min.	Typ.	Max.	Unit	Test Conditions	Figure	Note
Optimized Accuracy Range	I_P	-10	—	+10	A	—	—	a
Sensitivity	Sens	—	200	—	mV/A	$-10\text{A} \leq I_P \leq +10\text{A}$	1	b
Sensitivity Error	E_{SENS}	-5	—	5	%	$T_A = -40^\circ\text{C}$ to 110°C	3	b
		-3	—	3	%	$T_A = 25^\circ\text{C}$	3	b
Output Offset Error	V_{OE}	-55	—	55	mV	$T_A = -40^\circ\text{C}$ to 110°C	2	b
		-35	—	35	mV	$T_A = 25^\circ\text{C}$	2	b
Total Output Error	E_{TOT}	-5.5	—	5.5	%	$T_A = -40^\circ\text{C}$ to 110°C	4	b, c
		-3.5	—	3.5	%	$T_A = 25^\circ\text{C}$	4	b, c
Output Noise	$V_{\text{N(RMS)}}$	—	9	—	mVrms	BW = 2 kHz	—	d
Nonlinearity	NL	—	0.2	—	%	—	5	e
Sensitivity Error Lifetime Drift	$E_{\text{SENS_DRIFT}}$	—	± 2	—	%	$T_A = 25^\circ\text{C}$	—	—
Total Output Error Lifetime Drift	$E_{\text{TOT_DRIFT}}$	—	± 2	—	%	$T_A = 25^\circ\text{C}$	—	—

- The device may be operated at higher primary current levels, I_P , provided that the Maximum Junction Temperature, $T_{J(\text{MAX})}$, is not exceeded.
- See [Definition of Electrical Characteristics](#).
- The total output error in percentage is obtained by adding the sensitivity error plus offset error plus NL(%).
Total Output Error definition: $E_{\text{TOT}} = E_{\text{SENS}} + \text{NL} + 100V_{\text{OE}} / ((\text{Sens})I_P)$; $I_P = \pm 10\text{A} = 20\text{A}$ full range
- Output Noise is the noise level of ACHL-7241 expressed in root mean square (RMS) voltage.
- Nonlinearity is defined as half of the peak-to-peak output deviation from the best-fit line, expressed as a percentage of the full-scale output voltage. See [Definition of Electrical Characteristics](#) for the complete definition and formula.

ACHL-7242

Unless otherwise stated, all minimum/maximum specifications are obtained over recommended operating conditions. All typical values are based on $T_A = +25^\circ\text{C}$, $V_{DD} = 5.0\text{V}$, $C_F = 1\text{ nF}$.

Parameter	Symbol	Min.	Typ.	Max.	Unit	Test Conditions	Figure	Note
Optimized Accuracy Range	I_P	-20	—	+20	A	—	—	a
Sensitivity	Sens	—	100	—	mV/A	$-20\text{A} \leq I_P \leq +20\text{A}$	1	b
Sensitivity Error	E_{SENS}	-5	—	5	%	$T_A = -40^\circ\text{C}$ to 110°C	3	b
		-3	—	3	%	$T_A = 25^\circ\text{C}$	3	b
Output Offset Error	V_{OE}	-35	—	35	mV	$T_A = -40^\circ\text{C}$ to 110°C	2	b
		-25	—	25	mV	$T_A = 25^\circ\text{C}$	2	b
Total Output Error	E_{TOT}	-5.5	—	5.5	%	$T_A = -40^\circ\text{C}$ to 110°C	4	b, c
		-3.5	—	3.5	%	$T_A = 25^\circ\text{C}$	4	b, c
Output Noise	$V_{\text{N(RMS)}}$	—	4.1	—	mVrms	BW = 2 kHz	—	d
Nonlinearity	NL	—	0.12	—	%	—	5	e
Sensitivity Error Lifetime Drift	$E_{\text{SENS_DRIFT}}$	—	± 2	—	%	$T_A = 25^\circ\text{C}$	—	—
Total Output Error Lifetime Drift	$E_{\text{TOT_DRIFT}}$	—	± 2	—	%	$T_A = 25^\circ\text{C}$	—	—

- The device may be operated at higher primary current levels, I_P , provided that the Maximum Junction Temperature, $T_{J(\text{MAX})}$, is not exceeded.
- See [Definition of Electrical Characteristics](#).
- The total output error in percentage is obtained by adding the sensitivity error plus offset error plus NL(%).
Total Output Error definition: $E_{\text{TOT}} = E_{\text{SENS}} + \text{NL} + 100V_{\text{OE}} / ((\text{Sens})I_P)$; $I_P = \pm 20\text{A} = 40\text{A}$ full range
- Output Noise is the noise level of ACHL-7242 expressed in root mean square (RMS) voltage.
- Nonlinearity is defined as half of the peak-to-peak output deviation from the best-fit line, expressed as a percentage of the full-scale output voltage. See [Definition of Electrical Characteristics](#) for the complete definition and formula.

Package Characteristics

Parameter	Symbol	Min.	Typ.	Max.	Unit	Test Condition	Note
Input-Output Momentary Withstand Voltage	V _{ISO}	5000	—	—	V _{RMS}	RH < 50%, t = 1 minute, T _A = 25°C	a, b, c
Resistance (Input-Output)	R _{I-O}	—	10 ¹⁴	—	Ω	V _{I-O} = 500 V _{DC}	c
Capacitance (Input-Output)	C _{I-O}	—	1.2	—	pF	f = 1 MHz	c
Junction-to-Ambient Thermal Resistance (due to primary conductor)	R _{θ12}	—	26.3	—	°C/W	Based on the Broadcom evaluation board	d
Junction-to-Ambient Thermal Resistance (due to IC)	R _{θ22}	—	12.8	—	°C/W	Based on the Broadcom evaluation board	d

- In accordance to UL/cUL, each device is proof-tested by applying an insulation test voltage ≤ 5000 V_{RMS} for 1 second.
- The Input-Output Momentary Withstand Voltage is a dielectric voltage rating that should not be interpreted as an input-output continuous voltage rating.
- This is a two-terminal measurement: pins 1 through 6 are shorted together, and pins 7 through 12 are shorted together.
- The Broadcom evaluation board has 650 mm² (total area including the top and bottom copper minus the mounting holes) of 4-oz copper connected to pins 1, 2, and 3, and pins 4, 5, and 6. See [Thermal Consideration](#) for additional information on thermal characterization.

Typical Performance Plots

All typical plots are based on $T_A = 25^\circ\text{C}$, $V_{DD} = 5\text{V}$, $C_F = 1\text{ nF}$, unless otherwise stated.

Figure 1: Sensitivity vs. Temperature

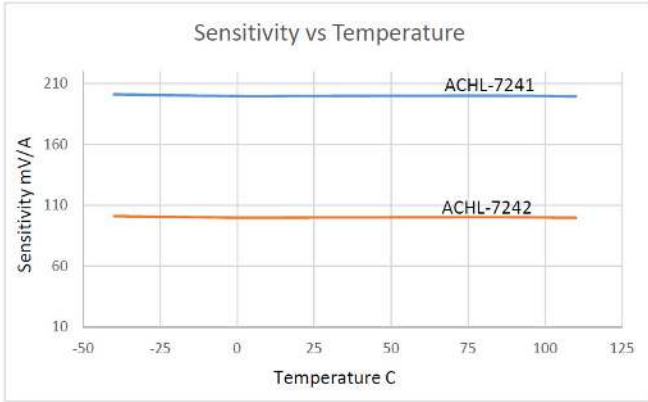

Figure 2: Offset Error vs. Temperature

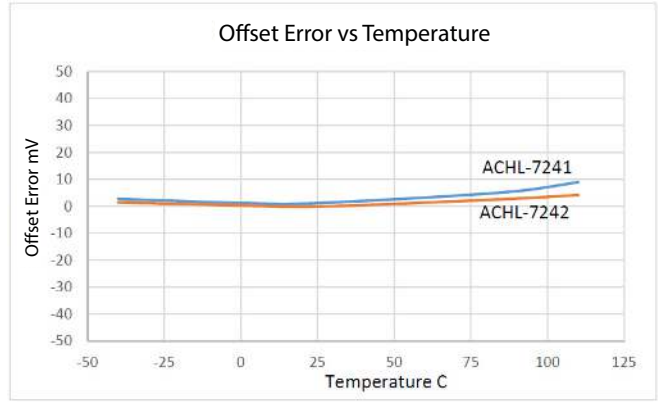

Figure 3: Sensitivity Error vs. Temperature

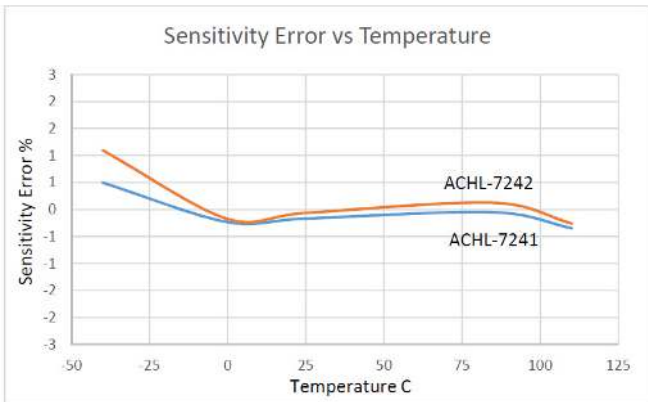

Figure 4: Total Output Error vs. Temperature

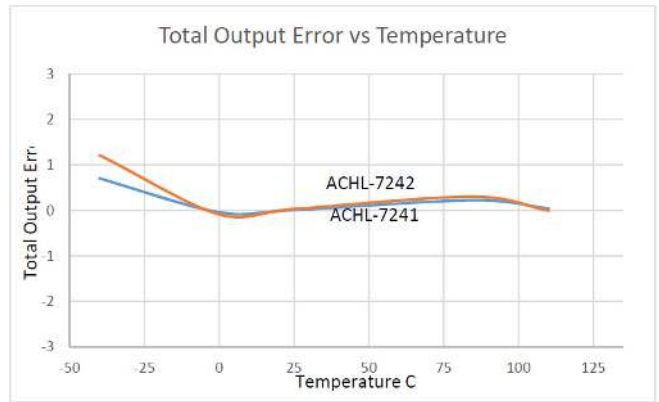

Figure 5: Nonlinearity vs. Temperature

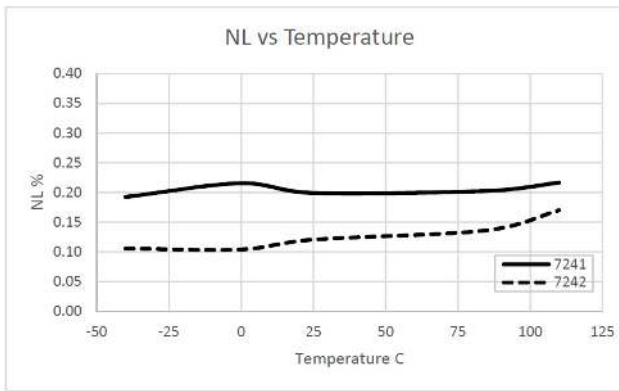

Figure 6: Supply Current vs. Supply Voltage



Figure 7: Output Voltage vs. Sensed Current

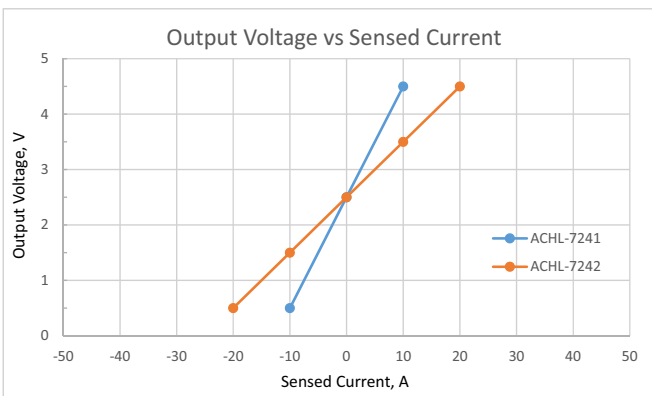

Figure 8: Power-On Time vs. External Filter

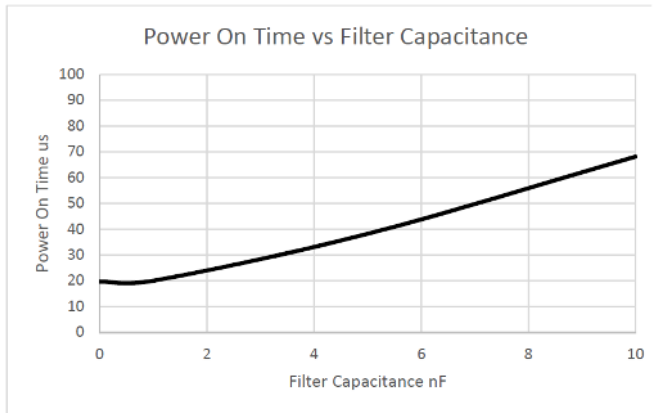

Figure 9: Rise Response Time vs. External Filter

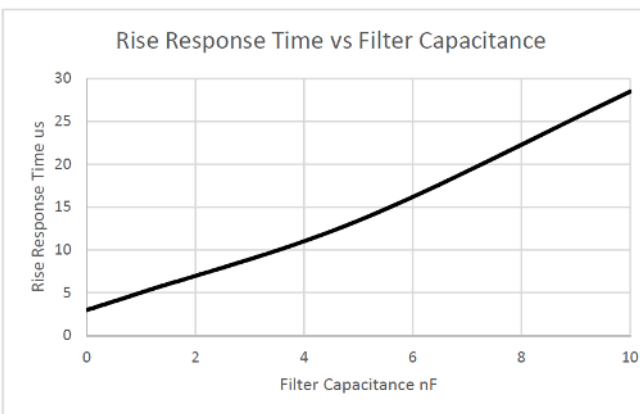

Figure 10: Rise Time vs. External Filter

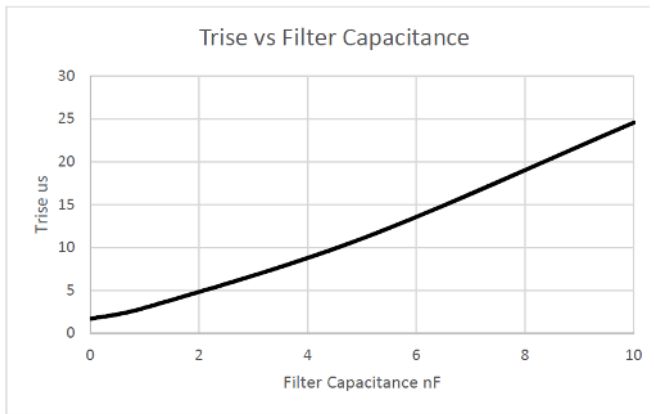

Figure 11: Fall Response Time vs. External Filter

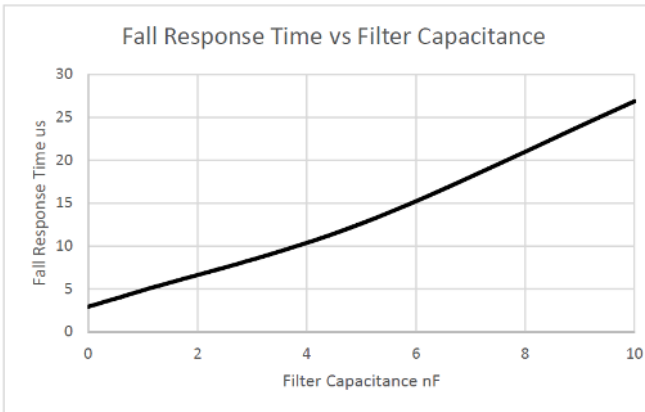

Figure 12: Tfall vs. External Filter

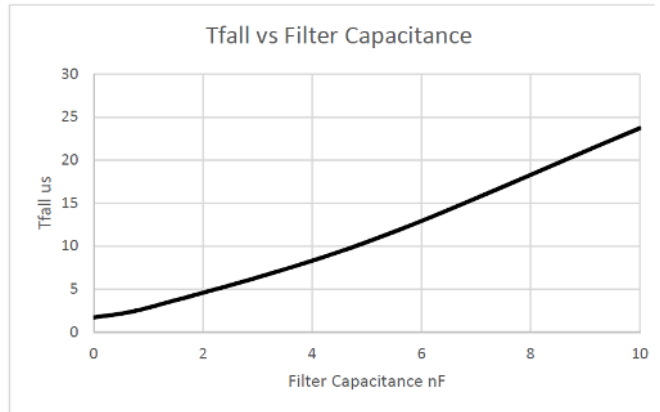
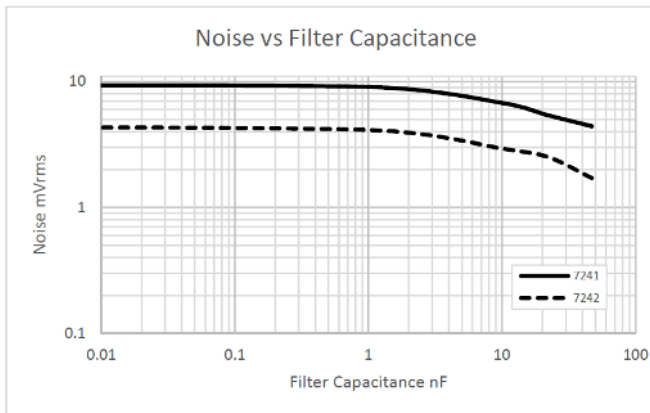

Figure 13: Output Noise vs. External Filter



Definition of Electrical Characteristics

The ACHL-7241 and ACHL-7242 products are Hall Effect current sensors (HES) that each outputs an analog voltage proportional to the magnetic field intensity caused by the current flowing through the input primary conductor. Without a magnetic field, the output voltage is half of the supply voltage. It can detect both DC and AC current.

Ratiometric Output

The output voltage of the ACHL-7241 and ACHL-7242 HES are ratiometric or proportional to the supply voltage. The sensitivity (Sens) of the device and the quiescent output voltage changes when there is a change in the supply voltage (V_{DD}). For example, for ACHS-7125 when the V_{DD} is increased by +10% from 5V to 5.5V, the quiescent output voltage changes from 2.5V to 2.75V, and the sensitivity also changes from 40 mV/A to 44 mV/A.

Sensitivity

The output sensitivity (Sens) is the ratio of the output voltage (V_{OUT}) over the input current (I_P) flowing through the primary conductor. It is expressed in mV/A. When an applied current flows through the input primary conductor, it generates a magnetic field which the Hall IC converts into a voltage. The proportional voltage is provided by the Hall IC, which is programmed in the factory for accuracy after packaging. The output voltage has a positive slope when an increasing current flows through pins 1, 2, and 3 to pins 4, 5, and 6. Sensitivity Error (E_{SENS}) is the difference between the measured sensitivity and the ideal sensitivity expressed in percentage (%).

Nonlinearity

Nonlinearity is defined as half of the peak-to-peak output deviation from the best-fit line (BFL), expressed as a percentage of the full-scale output voltage. The full-scale output voltage is the product of the sensitivity (Sens) and full scale input current (I_P).

$$NL (\%) = \frac{[(\text{Max}\Delta \text{ from BFL} - \text{Min}\Delta \text{ from BFL}) / 2] \times 100\%}{\text{Sens} \times \text{full scale } I_P}$$

Figure 14: Nonlinearity Calculation

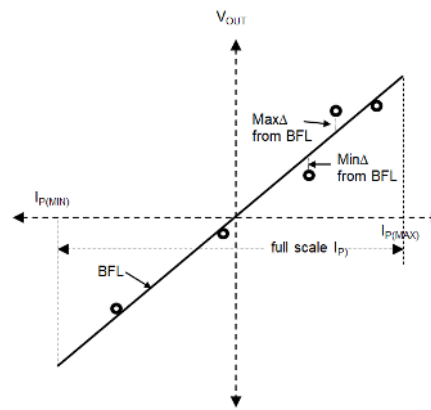

Zero Current Output Voltage (or Offset Voltage)

This is the output voltage of ACHL-7241 or ACHL-7242 when the primary current is zero. Zero current output voltage is half of the supply voltage ($V_{DD}/2$).

Zero Current Output Error (or Offset Error)

This is the voltage difference between the measured output voltage and the ideal output voltage ($V_{DD}/2$) when there is no input current to the device.

Total Output Error

Total output error in percentage is obtained by adding the sensitivity error plus offset error plus NL(%).

$$E_{TOT} = E_{SENS} + NL + 100V_{OE} / (\text{Sens} \times I_P)$$

Power-On Time

This is the time required for the internal circuitry of the device to be ready during the ramping of the supply voltage. Power-on time is defined as the finite time required for the output voltage to settle after the supply voltage reached its recommended operating voltage.

FILTER Pin

Each of the ACHL-7241 and ACHL-7242 ICs has a FILTER pin for improving the signal-to-noise ratio of the device. This eliminates the need for external RC filter to the V_{OUT} pin of the device, which can cause attenuation of the output signal. A ceramic capacitor, C_F, can be connected between the FILTER pin to GND.

Rise/Fall Times (tr/tf)

Rise time is the time interval between when the sensor IC output rise from 20%, and when it reaches 80% of its full scale output value, while Fall time is the time interval between when the Sensor IC output falls from 80%, and when it reaches 20% of its full scale output value as shown in Figure 15.

Figure 15: Rise/Fall Times and Rise/Fall Response Times

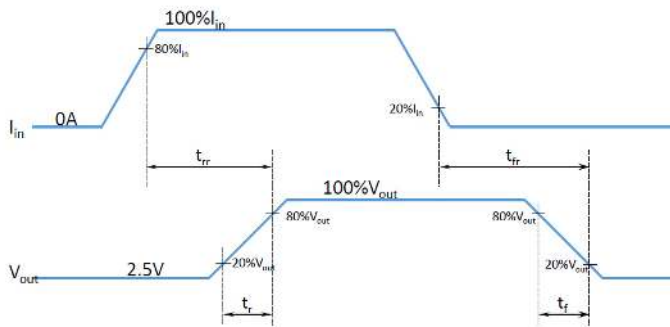

Rise/Fall Response Times (trr/tfr)

Rise response time is the time interval between when the input current rise reaches 80% of its full scale current value, and when the sensor IC output rise reaches 80% of its full scale voltage value, while Fall response time is the time interval between when the input current fall reaches 20% of its full scale current value, and when the sensor IC output fall reaches 20% of its full scale voltage value, as shown in Figure 15.

Application Information

PCB Layout

The design of the printed circuit board (PCB) should follow good layout practices, such as keeping bypass capacitors close to the supply pin and the use of ground and power planes. A bypass capacitor must be connected between pins 7, 10, and 12 of the device. The layout of the PCB can also affect the common mode transient immunity of the device due to stray capacitive coupling between the input and output circuits. To obtain maximum common mode transient immunity performance, the layout of the PCB should minimize any stray coupling by maintaining the maximum possible distance between the input and output sides of the circuit and ensuring that any ground or power plane on the PCB does not pass directly below or extend much wider than the body of the device.

Land Pattern for 4-mm Board Creepage

For applications that require PCB creepage of 8 mm between input and output sides, the land pattern in Figure 16 can be used.

Figure 16: Land Pattern for 8-mm Creepage

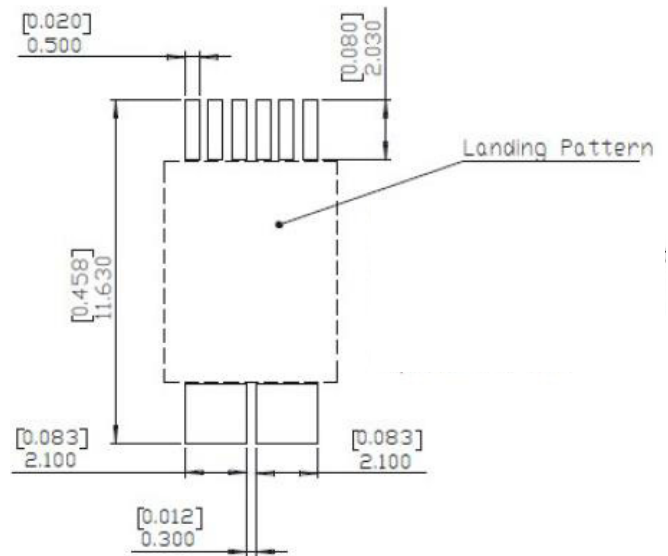

Effect of PCB Layout on Sensitivity

Refer to ACHS-712x for information on sensitivity.

Thermal Consideration

The evaluation board used in the thermal characterization is shown in [Figure 17](#) and [Figure 18](#). The inputs IP+ and IP- are each connected to input plane of 4 oz. copper with at least 650-mm² total area (including top and bottom planes, minus the screws mounting holes). The output side GND is connected to a ground plane of 4 oz. copper with 460-mm² total area (including top and bottom planes). The 4 oz. copper enables the board to conduct higher current and achieve good thermal distribution in a limited space.

Figure 17: Broadcom Evaluation Board – Top Layer



Figure 18: Broadcom Evaluation Board – Bottom Layer



Copyright © 2021 Broadcom. All Rights Reserved. The term “Broadcom” refers to Broadcom Inc. and/or its subsidiaries. For more information, go to www.broadcom.com. All trademarks, trade names, service marks, and logos referenced herein belong to their respective companies.

Broadcom reserves the right to make changes without further notice to any products or data herein to improve reliability, function, or design. Information furnished by Broadcom is believed to be accurate and reliable. However, Broadcom does not assume any liability arising out of the application or use of this information, nor the application or use of any product or circuit described herein, neither does it convey any license under its patent rights nor the rights of others.