

# 2SA1488/1488A

Silicon PNP Epitaxial Planar Transistor (Complement to type 2SC3851/A)

Application : Audio and General Purpose

■ Absolute maximum ratings (Ta=25°C)

Symbol	Ratings		Unit
	2SA1488	2SA1488A	
V <sub>CB0</sub>	-60	-80	V
V <sub>CE0</sub>	-60	-80	V
V <sub>EB0</sub>	-6		V
I <sub>c</sub>	-4		A
I <sub>b</sub>	-1		A
P <sub>c</sub>	25(Tc=25°C)		W
T <sub>j</sub>	150		°C
T <sub>stg</sub>	-55 to +150		°C

■ Electrical Characteristics (Ta=25°C)

Symbol	Conditions	Ratings		Unit
		2SA1488	2SA1488A	
I <sub>cB0</sub>	V <sub>CB</sub> =	-100max	-100max	μA
I <sub>eB0</sub>	V <sub>EB</sub> =-6V	-60	-80	V
I <sub>eB0</sub>	V <sub>EB</sub> =-6V	-100max		μA
V <sub>(BR)CEO</sub>	I <sub>c</sub> =-25mA	-60min	-80min	V
h <sub>FE</sub>	V <sub>CE</sub> =-4V, I <sub>c</sub> =-1A	40min		
V <sub>CE(sat)</sub>	I <sub>c</sub> =-2A, I <sub>b</sub> =-0.2A	-0.5max		V
f <sub>T</sub>	V <sub>CE</sub> =-12V, I <sub>E</sub> =0.2A	15typ		MHz
C <sub>OB</sub>	V <sub>CB</sub> =-10V, f=1MHz	90typ		pF

External Dimensions FM20 (TO220F)

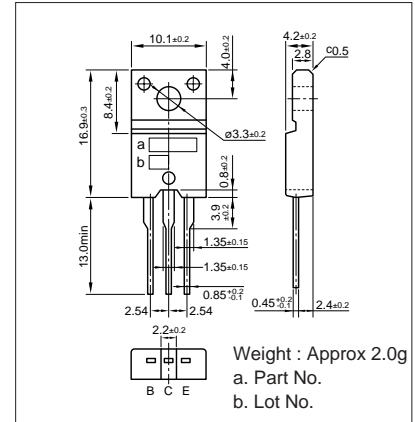

■ Typical Switching Characteristics (Common Emitter)

V <sub>CC</sub> (V)	R <sub>L</sub> (Ω)	I <sub>c</sub> (A)	V <sub>BB1</sub> (V)	V <sub>BB2</sub> (V)	I <sub>b1</sub> (mA)	I <sub>b2</sub> (mA)	t <sub>on</sub> (μs)	t <sub>stg</sub> (μs)	t <sub>f</sub> (μs)
-12	6	-2	-10	5	-200	200	0.25typ	0.75typ	0.25typ

I<sub>c</sub>-V<sub>CE</sub> Characteristics (Typical)

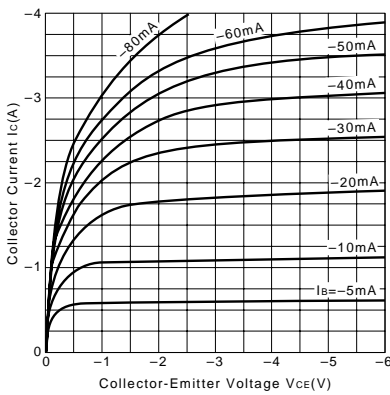

V<sub>CE(sat)</sub>-I<sub>b</sub> Characteristics (Typical)

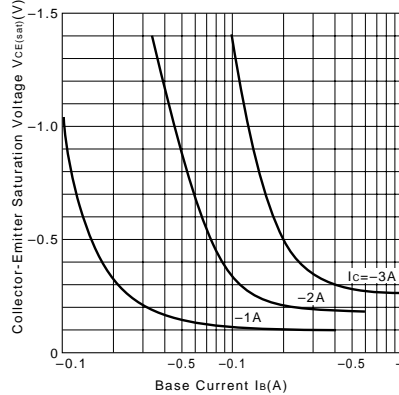

I<sub>c</sub>-V<sub>BE</sub> Temperature Characteristics (Typical)

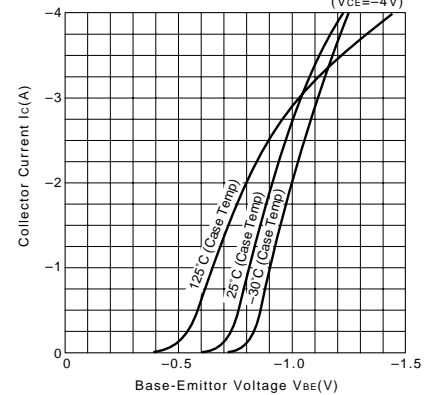

h<sub>FE</sub>-I<sub>c</sub> Characteristics (Typical)

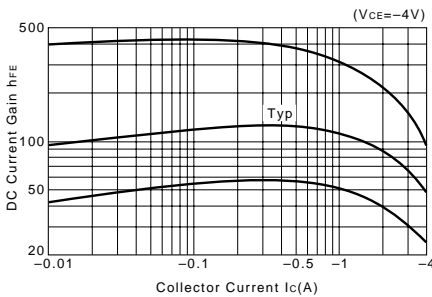

h<sub>FE</sub>-I<sub>c</sub> Temperature Characteristics (Typical)

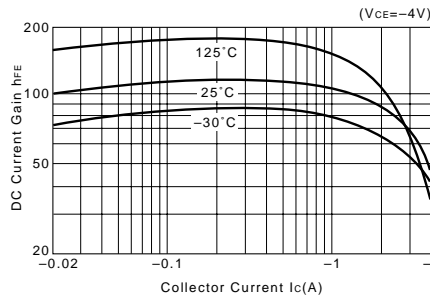

θ<sub>j-a</sub>-t Characteristics

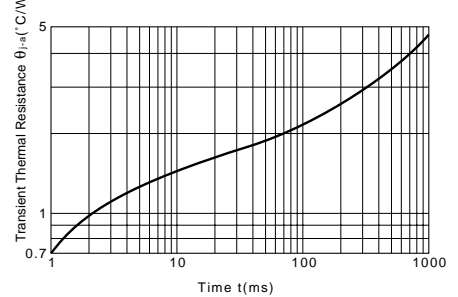

f<sub>T</sub>-I<sub>E</sub> Characteristics (Typical)

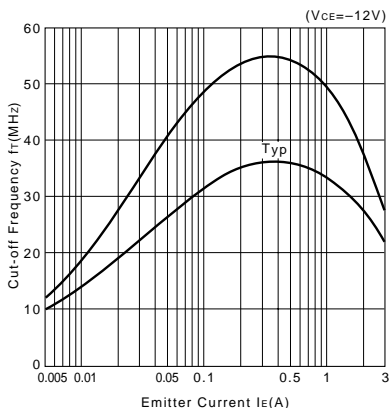

Safe Operating Area (Single Pulse)

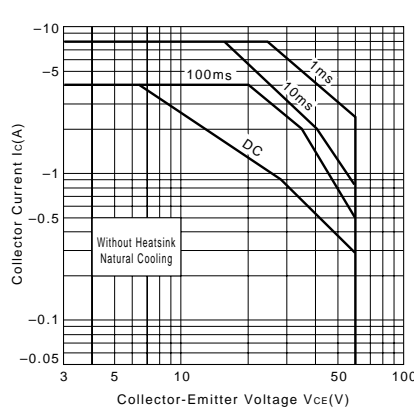

P<sub>c</sub>-T<sub>a</sub> Derating

