

National Semiconductor is now part of
Texas Instruments.

Search <http://www.ti.com/> for the latest technical
information and details on our current products and services.

LMC6442

Dual Micropower Rail-to-Rail Output Single Supply Operational Amplifier

General Description

The LMC6442 is ideal for battery powered systems, where very low supply current (less than one microamp per amplifier) and Rail-to-Rail output swing is required. It is characterized for 2.2V to 10V operation, and at 2.2V supply, the LMC6442 is ideal for single (Li-Ion) or two cell (NiCad or alkaline) battery systems.

The LMC6442 is designed for battery powered systems that require long service life through low supply current, such as smoke and gas detectors, and pager or personal communications systems.

Operation from single supply is enhanced by the wide common mode input voltage range which includes the ground (or negative supply) for ground sensing applications. Very low (5 fA, typical) input bias current and near constant supply current over supply voltage enhance the LMC6442's performance near the end-of-life battery voltage.

Designed for closed loop gains of greater than plus two (or minus one), the amplifier has typically 9.5 KHz GBWP (Gain Bandwidth Product). Unity gain can be used with a simple compensation circuit, which also allows capacitive loads of up to 300 pF to be driven, as described in the Application Notes section.

Features

(Typical, $V_S = 2.2V$)

- Output Swing to within 30 mV of supply rail
- High voltage gain 103 dB
- Gain Bandwidth Product 9.5 KHz
- Guaranteed for: 2.2V, 5V, 10V
- Low Supply Current 0.95 μA /Amplifier
- Input Voltage Range $-0.3V$ to V^+ -0.9V
- 2.1 μW /Amplifier Power consumption
- Stable for $A_V \geq +2$ or $A_V \leq -1$

Applications

- Portable instruments
- Smoke/gas/CO/fire detectors
- Pagers/cell phones
- Instrumentation
- Thermostats
- Occupancy sensors
- Cameras
- Active badges

Connection Diagram

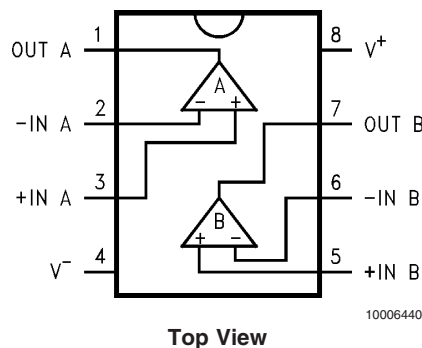

Absolute Maximum Ratings (Note 1)

If Military/Aerospace specified devices are required, please contact the National Semiconductor Sales Office/Distributors for availability and specifications.

ESD Tolerance (Note 2)	2 kV
Differential Input Voltage	±Supply Voltages
Voltage at Input/Output Pin	(V ⁺) + 0.3V, (V ⁻) – 0.3V
Supply Voltage (V ⁺ – V ⁻):	16V
Current at Input Pin (Note 10)	±5 mA
Current at Output Pin(Notes 3, 7)	±30 mA
Lead Temp. (soldering 10 sec)	260°C
Storage Temp. Range:	–65°C to +150°C

Junction Temp. (Note 4)

150°C

Operating Ratings(Note 1)

Supply Voltage	1.8V ≤ V _S ≤ 11V
Junction Temperature	–40°C < T _J < +85°C
Range:	LMC6442AI, LMC6442I
Thermal Resistance (θ _{JA})	
M Package, 8-pin Surface Mount	193°C/W
N Package, 8-pin Molded DIP	115°C/W

2.2V Electrical Characteristics

Unless otherwise specified, all limits guaranteed for T_J = 25°C, V⁺ = 2.2V, V⁻ = 0V, V_{CM} = V_O = V⁺/2, and R_L = 1 MΩ to V⁺/2. **Boldface** limits apply at the temperature extremes.

Symbol	Parameter	Conditions	Typ (Note 5)	LMC6442AI Limit (Note 6)	LMC6442I Limit (Note 6)	Units
DC Electrical Characteristics						
V _{OS}	Input Offset Voltage		–0.75	±3 ±4	±7 ±8	mV max
TCV _{OS}	Temp. coefficient of input offset voltage		0.4			μV/°C
I _B	Input Bias Current	(Note 14)	0.005	4	4	pA max
I _{OS}	Input Offset Current	(Note 14)	0.0025	2	2	pA max
CMRR	Common Mode Rejection Ratio	–0.1V ≤ V _{CM} ≤ 0.5V	92	67 67	67 67	dB min
C _{IN}	Common Mode Input Capacitance		4.7			pF
PSRR	Power Supply Rejection Ratio	V _S = 2.5 V to 10V	95	75 75	75 75	dB min
V _{CM}	Input Common-Mode Voltage Range	CMRR ≥ 50 dB	1.3	1.05 0.95	1.05 0.95	V min
			–0.3	–0.2 0	–0.2 0	V max
A _V	Large Signal Voltage Gain	Sourcing (Note 11)	100			dB min
		Sinking (Note 11)	94			
		V _O = 0.22V to 2V	103	80	80	
V _O	Output Swing	V _{ID} = 100 mV (Note 13)	2.18	2.15 2.15	2.15 2.15	V min
		V _{ID} = –100 mV (Note 13)	22	60 60	60 60	mV max
I _{SC}	Output Short Circuit Current	Sourcing, V _{ID} = 100 mV (Notes 12, 13)	50	18 17	18 17	μA min
		Sinking, V _{ID} = –100 mV (Notes 12, 13)	50	20 19	20 19	
I _S	Supply Current (2 amplifiers)	R _L = open	1.90	2.4 3.0	2.6 3.2	μA max
		V ⁺ = 1.8V, R _L = open	2.10			

2.2V Electrical Characteristics (Continued)

Unless otherwise specified, all limits guaranteed for $T_J = 25^\circ\text{C}$, $V^+ = 2.2\text{V}$, $V^- = 0\text{V}$, $V_{\text{CM}} = V_O = V^+ / 2$, and $R_L = 1\text{ M}\Omega$ to $V^+ / 2$.

Boldface limits apply at the temperature extremes.

Symbol	Parameter	Conditions	Typ (Note 5)	LMC6442AI Limit (Note 6)	LMC6442I Limit (Note 6)	Units
AC Electrical Characteristics						
SR	Slew Rate (Note 8)		2.2			V/ms
GBWP	Gain-Bandwidth Product		9.5			KHz
ϕ_m	Phase Margin	(Note 15)	63			deg

5V Electrical Characteristics

Unless otherwise specified, all limits guaranteed for $T_J = 25^\circ\text{C}$, $V^+ = 5\text{V}$, $V^- = 0\text{V}$, $V_{\text{CM}} = V_O = V^+ / 2$, and $R_L = 1\text{ M}\Omega$ to $V^+ / 2$.

Boldface limits apply at the temperature extremes.

Symbol	Parameter	Conditions	Typ (Note 5)	LMC6442AI Limit (Note 6)	LMC6442I Limit (Note 6)	Units
DC Electrical Characteristics						
V_{OS}	Input Offset Voltage		-0.75	± 3 ± 4	± 7 ± 8	mV max
TCV_{OS}	Temp. coefficient of input offset voltage		0.4			$\mu\text{V}/^\circ\text{C}$
I_B	Input Bias Current	(Note 14)	0.005	4	4	μA max
I_{OS}	Input Offset Current	(Note 14)	0.0025	2	2	μA max
CMRR	Common Mode Rejection Ratio	$-0.1\text{V} \leq V_{\text{CM}} \leq 3.5\text{V}$	102	70 70	70 70	dB min
C_{IN}	Common Mode Input Capacitance		4.1			pF
PSRR	Power Supply Rejection Ratio	$V_S = 2.5\text{V}$ to 10V	95	75 75	75 75	dB min
V_{CM}	Input Common-Mode Voltage Range	CMRR $\geq 50\text{ dB}$	4.1	3.85 3.75	3.85 3.75	V min
			-0.4	-0.2 0	-0.2 0	V max
A_V	Large Signal Voltage Gain	Sourcing (Note 11)	100			dB min
		Sinking (Note 11)	94			
		$V_O = 0.5\text{V}$ to 4.5V	103	80	80	
V_O	Output Swing	$V_{\text{ID}} = 100\text{ mV}$ (Note 13)	4.99	4.95 4.95	4.95 4.95	V min
		$V_{\text{ID}} = -100\text{ mV}$ (Note 13)	20	50 50	50 50	mV max
I_{SC}	Output Short Circuit Current	Sourcing, $V_{\text{ID}} = 100\text{ mV}$ (Notes 12, 13)	500	300 200	300 200	μA min
		Sinking, $V_{\text{ID}} = -100\text{ mV}$ (Notes 12, 13)	350	200 150	200 150	
I_S	Supply Current (2 amplifiers)	$R_L = \text{open}$	1.90	2.4 3.0	2.6 3.2	μA max

5V Electrical Characteristics (Continued)

Unless otherwise specified, all limits guaranteed for $T_J = 25^\circ\text{C}$, $V^+ = 5\text{V}$, $V^- = 0\text{V}$, $V_{\text{CM}} = V_O = V^+/2$, and $R_L = 1\text{ M}\Omega$ to $V^+/2$. **Boldface** limits apply at the temperature extremes.

Symbol	Parameter	Conditions	Typ (Note 5)	LMC6442AI Limit (Note 6)	LMC6442I Limit (Note 6)	Units
AC Electrical Characteristics						
SR	Slew Rate (Note 8)		4.1	2.5	2.5	V/ms
GBWP	Gain-Bandwidth Product		10			KHz
ϕ_m	Phase Margin	(Note 15)	64			deg
THD	Total Harmonic Distortion	$A_V = +2$, $f = 100\text{ Hz}$, $R_L = 10\text{ M}\Omega$, $V_{\text{OUT}} = 1\text{ V}_{\text{PP}}$	0.08			%

10V Electrical Characteristics

Unless otherwise specified, all limits guaranteed for $T_J = 25^\circ\text{C}$, $V^+ = 10\text{V}$, $V^- = 0\text{V}$, $V_{\text{CM}} = V_O = V^+/2$, and $R_L = 1\text{ M}\Omega$ to $V^+/2$. **Boldface** limits apply at the temperature extremes.

Symbol	Parameter	Conditions	Typ (Note 5)	LMC6442AI Limit (Note 6)	LMC6442I Limit (Note 6)	Units
DC Electrical Characteristics						
V_{OS}	Input Offset Voltage		-1.5	± 3 ± 4	± 7 ± 8	mV max
TCV_{OS}	Temp. coefficient of input offset voltage		0.4			$\mu\text{V}/^\circ\text{C}$
I_B	Input Bias Current	(Note 14)	0.005	4	4	μA max
I_{OS}	Input Offset Current	(Note 14)	0.0025	2	2	μA max
CMRR	Common Mode Rejection Ratio	$-0.1\text{V} \leq V_{\text{CM}} \leq 8.5\text{V}$	105	70 70	70 70	dB min
C_{IN}	Common Mode Input Capacitance		3.5			pF
PSRR	Power Supply Rejection Ratio	$V_S = 2.5\text{ V to } 10\text{V}$	95	75 75	75 75	dB min
V_{CM}	Input Common-Mode Voltage Range	CMRR $\geq 50\text{ dB}$	9.1	8.85 8.75	8.85 8.75	V min
			-0.4	-0.2 0	-0.2 0	V max
A_V	Large Signal Voltage Gain	Sourcing (Note 11)	120			dB min
		Sinking (Note 11)	100			
		$V_O = 0.5\text{V to } 9.5\text{V}$	104	80	80	
V_O	Output Swing	$V_{\text{ID}} = 100\text{ mV}$ (Note 13)	9.99	9.97 9.97	9.97 9.97	V min
		$V_{\text{ID}} = -100\text{ mV}$ (Note 13)	22	50 50	50 50	mV max
I_{SC}	Output Short Circuit Current	Sourcing, $V_{\text{ID}} = 100\text{ mV}$ (Notes 12, 13)	2100	1200 1000	1200 1000	μA min
		Sinking, $V_{\text{ID}} = -100\text{ mV}$ (Notes 12, 13)	900	600 500	600 500	
I_S	Supply Current (2 amplifiers)	$R_L = \text{open}$	1.90	2.4 3.0	2.6 3.2	μA max

10V Electrical Characteristics (Continued)

Unless otherwise specified, all limits guaranteed for $T_J = 25^\circ\text{C}$, $V^+ = 10\text{V}$, $V^- = 0\text{V}$, $V_{\text{CM}} = V_O = V^+/2$, and $R_L = 1\text{ M}\Omega$ to $V^+/2$.

Boldface limits apply at the temperature extremes.

Symbol	Parameter	Conditions	Typ (Note 5)	LMC6442AI Limit (Note 6)	LMC6442I Limit (Note 6)	Units
AC Electrical Characteristics						
SR	Slew Rate(Note 8)		4.1	2.5	2.5	V/ms
GBWP	Gain-Bandwidth Product		10.5			KHz
ϕ_m	Phase Margin	(Note 15)	68			deg
e_n	Input-Referred Voltage Noise	$R_L = \text{open}$ $f = 10\text{ Hz}$	170			nV/ $\sqrt{\text{Hz}}$
i_n	Input-Referred Current Noise	$R_L = \text{open}$ $f = 10\text{ Hz}$	0.0002			pA/ $\sqrt{\text{Hz}}$
	Crosstalk Rejection	(Note 9)	85			dB

Electrical Characteristics (continued)

Note 1: Absolute Maximum Ratings indicate limits beyond which damage to the device may occur. Operating Ratings indicate conditions for which the device is intended to be functional, but specific performance is not guaranteed. For guaranteed specifications and the test conditions, see the Electrical Characteristics.

Note 2: Human body model, 1.5 k Ω in series with 100 pF.

Note 3: Applies to both single-supply and split-supply operation. Continuous short circuit operation at elevated ambient temperature can result in exceeding the maximum allowed junction temperature of 150°C. Output currents in excess of $\pm 30\text{ mA}$ over long term may adversely affect reliability.

Note 4: The maximum power dissipation is a function of $T_{J(\text{MAX})}$, θ_{JA} , and T_A . The maximum allowable power dissipation at any ambient temperature is $P_D = (T_{J(\text{MAX})} - T_A) / \theta_{JA}$. All numbers apply for packages soldered directly into a PC board.

Note 5: Typical Values represent the most likely parametric norm.

Note 6: All limits are guaranteed by testing or statistical analysis unless otherwise specified.

Note 7: Do not short circuit output to V^+ , when V^+ is greater than 13V or reliability will be adversely affected.

Note 8: Slew rate is the slower of the rising and falling slew rates.

Note 9: Input referred, $V^+ = 10\text{V}$ and $R_L = 10\text{ M}\Omega$ connected to 5V. Each amp excited in turn with 1 KHz to produce about 10 V_{PP} output.

Note 10: Limiting input pin current is only necessary for input voltages that exceed absolute maximum input voltage ratings.

Note 11: R_L connected to $V^+/2$. For Sourcing Test, $V_O > V^+/2$. For Sinking tests, $V_O < V^+/2$.

Note 12: Output shorted to ground for sourcing, and shorted to V^+ for sinking short circuit current test.

Note 13: V_{ID} is differential input voltage referenced to inverting input.

Note 14: Limits guaranteed by design.

Note 15: See the Typical Performance Characteristics and Application Notes sections for more details.

Typical Performance Characteristics $V_S = 5V$, Single Supply, $T_A = 25^\circ C$ unless otherwise specified

Total Supply Current vs. Supply Voltage

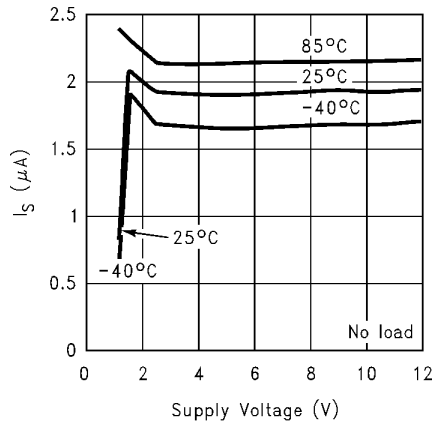

Total Supply Current vs. Supply Voltage (Negative Input Overdrive)

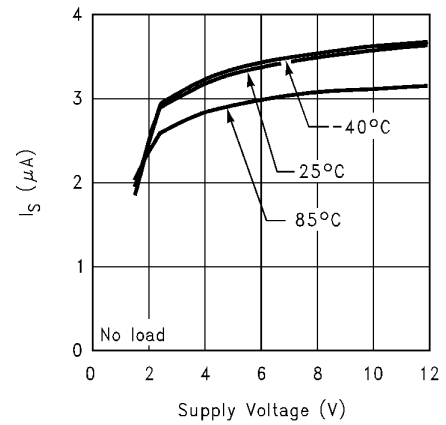

Total Supply Current vs. Supply Voltage (Positive Input Overdrive)

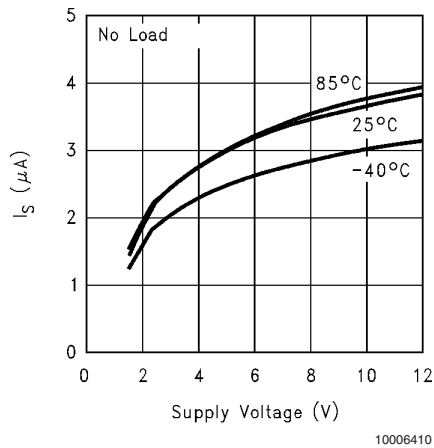

Input Bias Current vs. Temperature

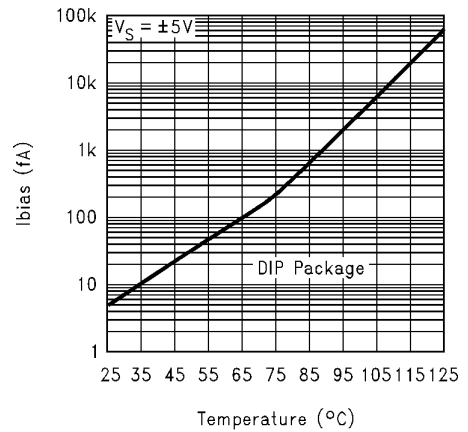

Offset Voltage vs. Common Mode Voltage ($V_S = 2.2V$)

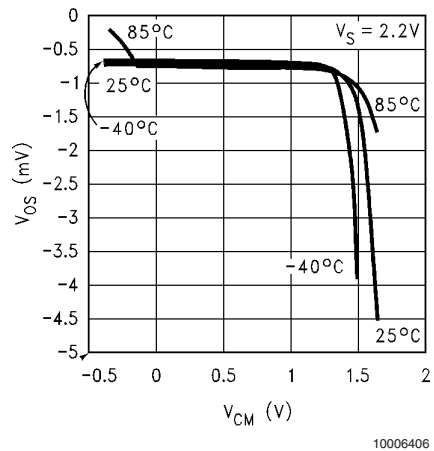

Offset Voltage vs. Common Mode Voltage ($V_S = 5V$)

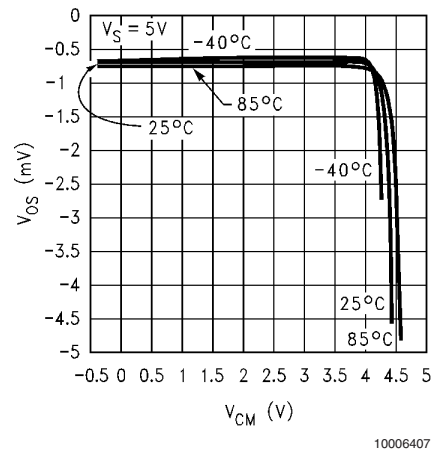

Typical Performance Characteristics $V_S = 5V$, Single Supply, $T_A = 25^\circ C$ unless otherwise specified (Continued)

Offset Voltage vs. Common Mode Voltage
($V_S = 10V$)

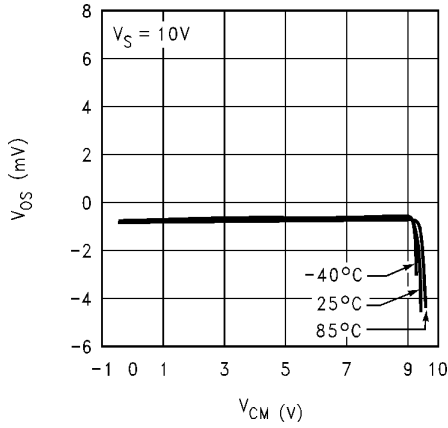

10006442

Swing Towards V^- vs. Supply Voltage

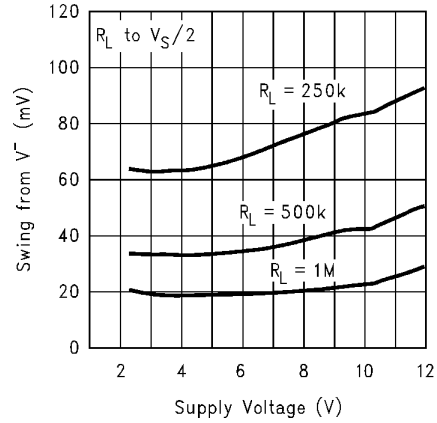

10006403

Swing Towards V^+ vs. Supply Voltage

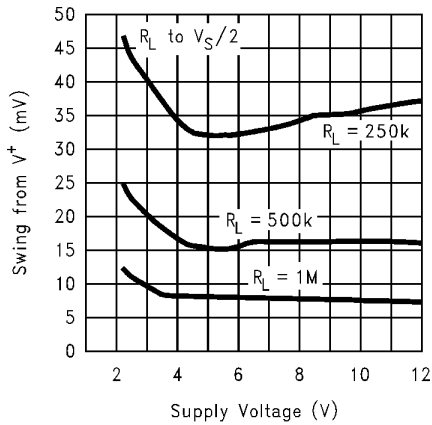

10006402

Swing From Rail(s) vs. Temperature

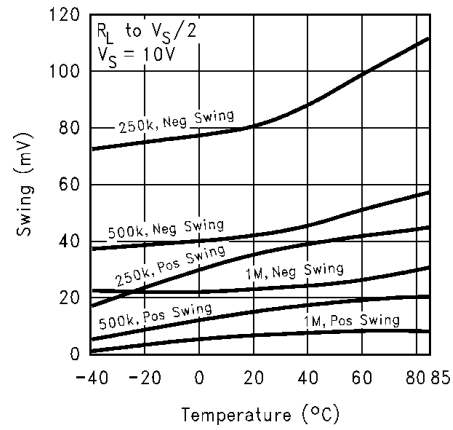

10006401

Output Source Current vs. Output Voltage

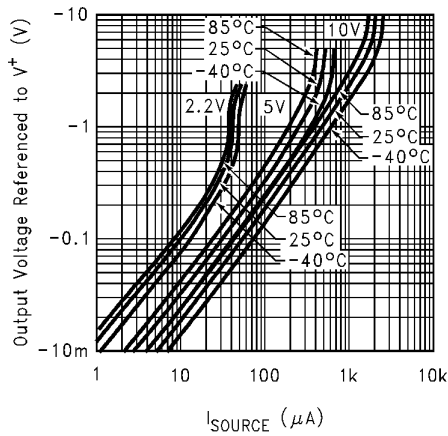

10006449

Output Sink Current vs. Output Voltage

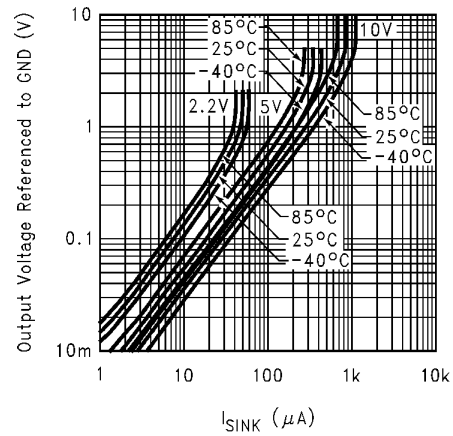

10006448

Typical Performance Characteristics $V_S = 5V$, Single Supply, $T_A = 25^\circ C$ unless otherwise specified (Continued)

Maximum Output Voltage vs. Load Resistance

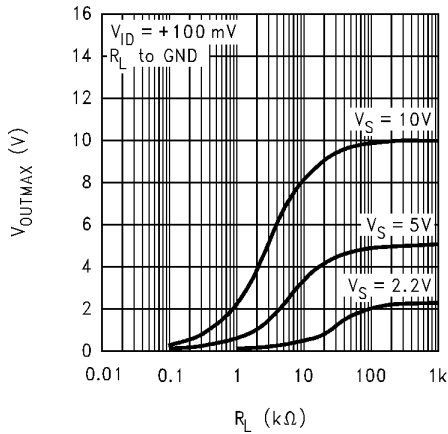

Large Signal Voltage Gain vs. Supply Voltage

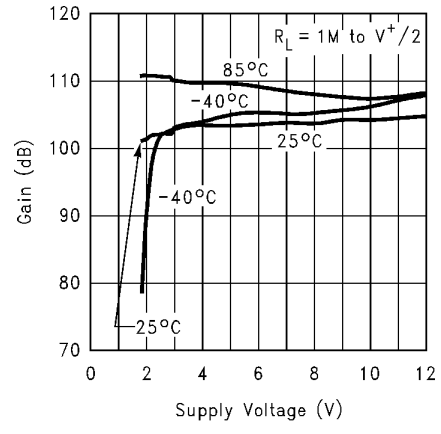

Open Loop Gain/Phase vs. Frequency

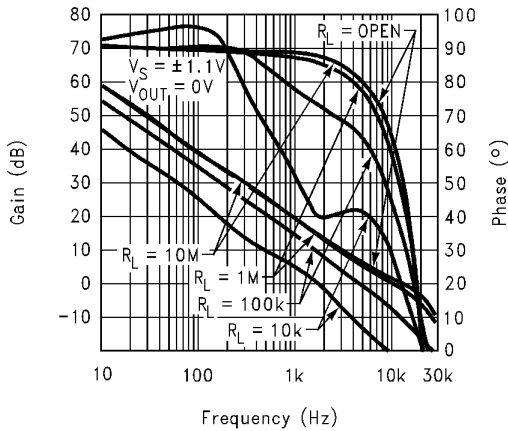

Open Loop Gain/Phase vs. Frequency For Various C_L (Z_L = 1 MΩ || C_L)

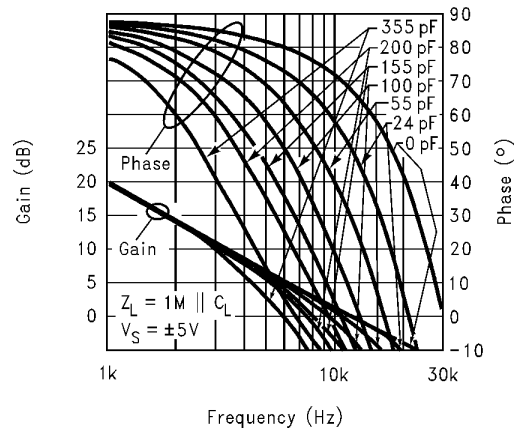

Open Loop Gain/Phase vs. Frequency For Various C_L (Z_L = 100 KΩ || C_L)

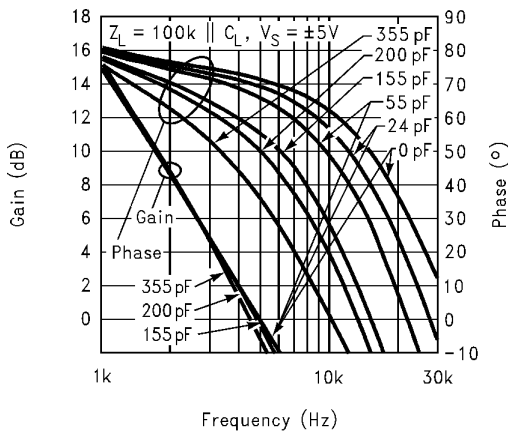

Gain Bandwidth Product vs. Supply Voltage

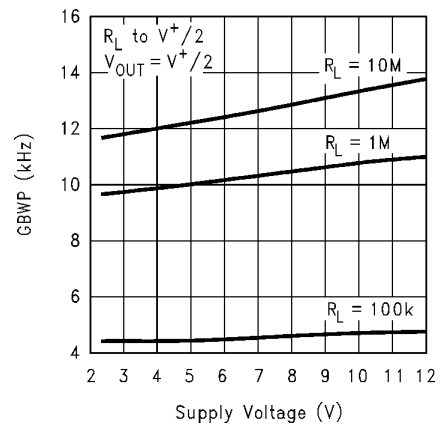

Typical Performance Characteristics $V_S = 5V$, Single Supply, $T_A = 25^\circ C$ unless otherwise specified (Continued)

Phase Margin (Worst Case) vs. Supply Voltage

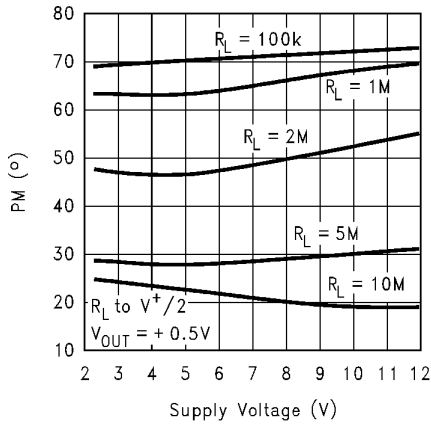

10006423

CMRR vs. Frequency

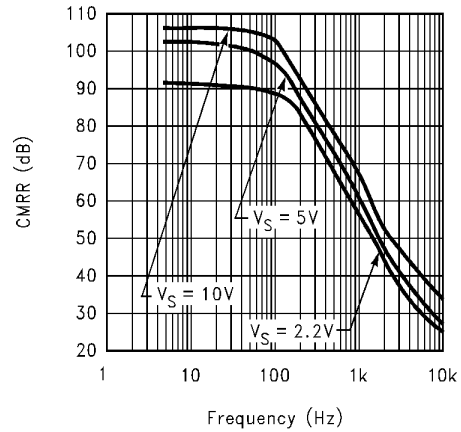

10006434

PSRR vs. Frequency

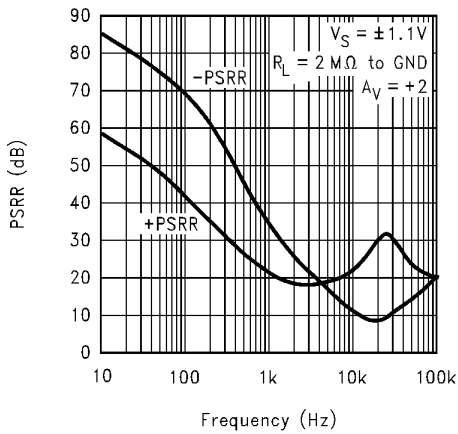

10006415

Positive Slew Rate vs. Supply Voltage

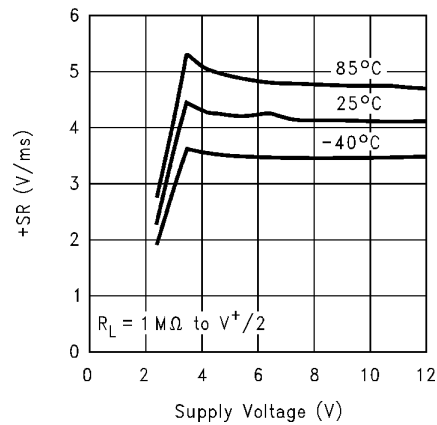

10006412

Negative Slew Rate vs. Supply Voltage

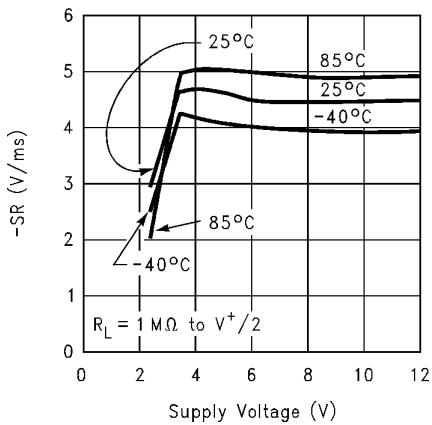

10006411

Crosstalk Rejection vs. Frequency

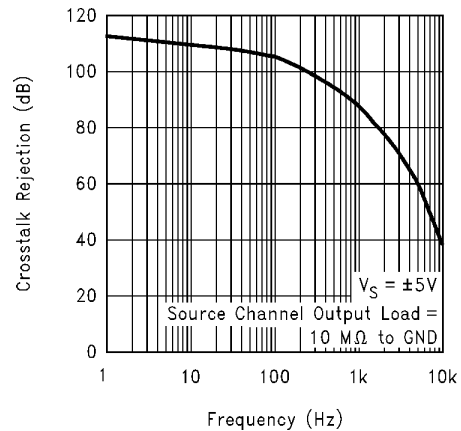

10006418

Typical Performance Characteristics $V_S = 5V$, Single Supply, $T_A = 25^\circ C$ unless otherwise specified (Continued)

Input Voltage Noise vs. Frequency

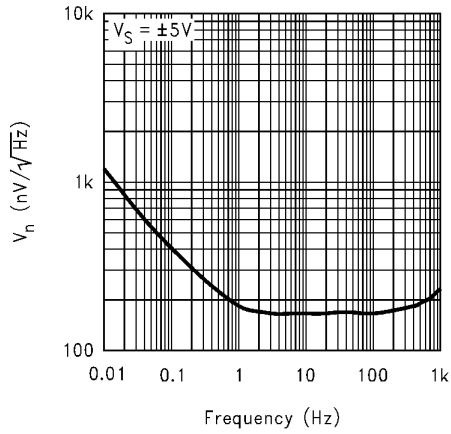

10006416

Output Impedance vs. Frequency

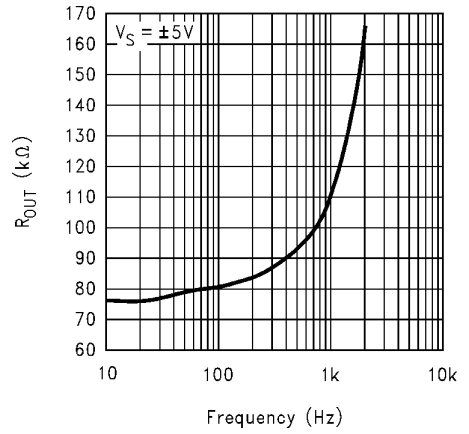

10006433

THD+N vs. Frequency

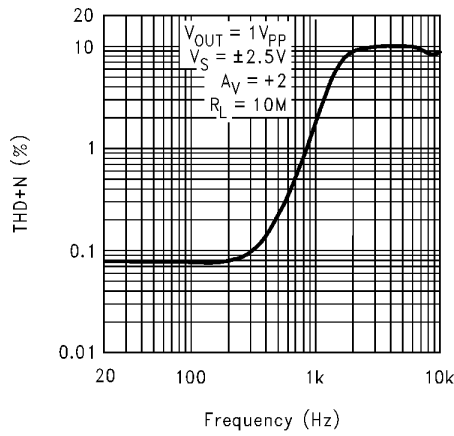

10006428

THD+N vs. Amplitude

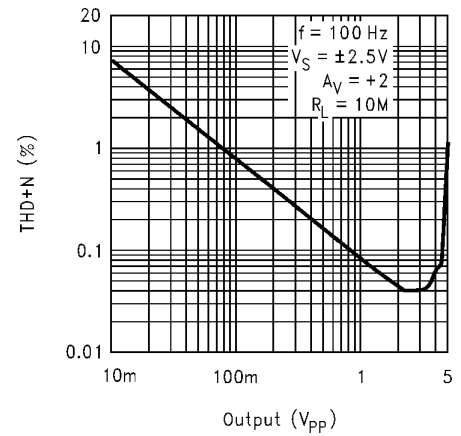

10006427

Maximum Output Swing vs. Frequency

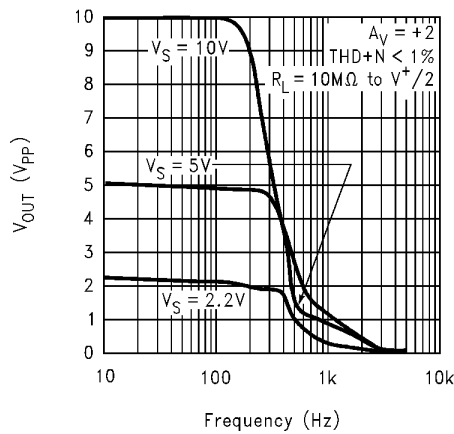

10006453

Small Signal Step Response
($A_V = +2$) ($C_L = 12\text{ pF}, 100\text{ pF}$)

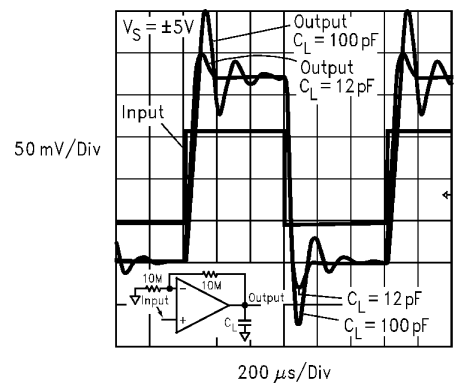

10006429

Typical Performance Characteristics $V_S = 5V$, Single Supply, $T_A = 25^\circ C$ unless otherwise specified (Continued)

Large Signal Step Response
($A_V = +2$) ($C_L = 100\text{ pF}$)

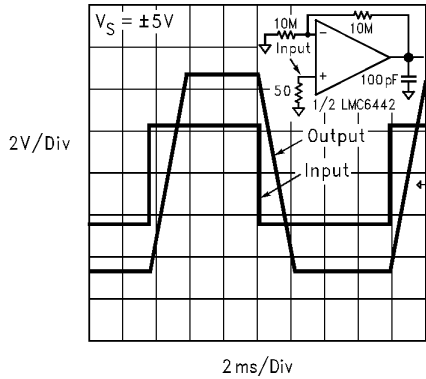

Small Signal Step Response
($A_V = -1$) ($C_L = 1M\Omega \parallel 100\text{ pF}, 200\text{ pF}$)

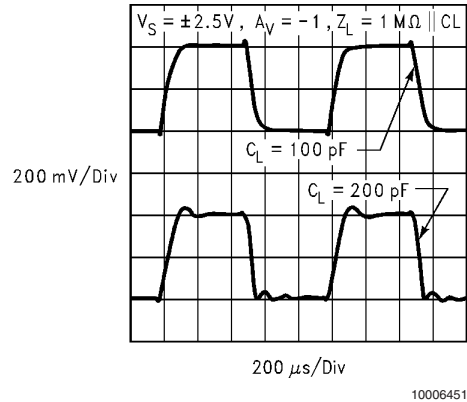

Small Signal Step Response
($A_V = +1$) For Various C_L

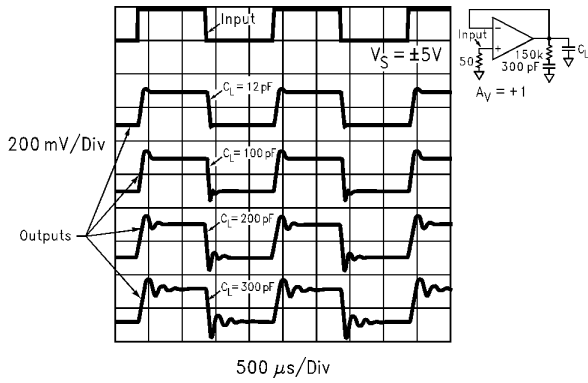

Large Signal Step Response
($A_V = +1$) ($C_L = 200\text{ pF}$)

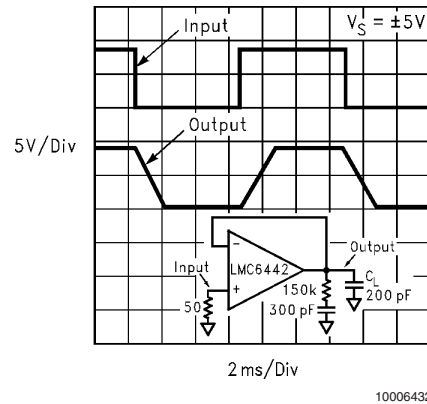

Applications Information

USING LMC6442 IN UNITY GAIN APPLICATIONS

LMC6442 is optimized for maximum bandwidth and minimal external components when operating at a minimum closed loop gain of +2 (or -1). However, it is also possible to operate the device in a unity gain configuration by adding external compensation as shown in *Figure 1*:

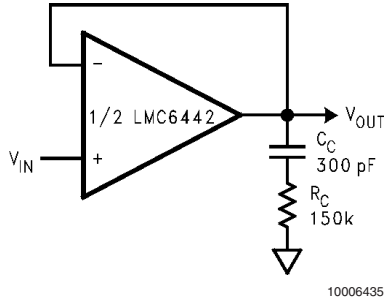

FIGURE 1. $A_V = +1$ Operation by adding C_C and R_C

Using this compensation technique it is possible to drive capacitive loads of up to 300 pF without causing oscillations (see the Typical Performance Characteristics for step response plots). This compensation can also be used with other gain settings in order to improve stability, especially when driving capacitive loads (for optimum performance, R_C and C_C may need to be adjusted).

USING “T” NETWORK

Compromises need to be made whenever high gain inverting stages need to achieve a high input impedance as well. This is especially important in low current applications which tend to deal with high resistance values. Using a traditional inverting amplifier, gain is inversely proportional to the resistor value tied between the inverting terminal and input while the input impedance is equal to this value. For example, in order to build an inverting amplifier with an input impedance of 10M Ω and a gain of 100, one needs to come up with a feedback resistor of 1000 M Ω -an expensive task.

An alternate solution is to use a “T” Network in the feedback path, as shown in *Figure 2*.

Closed loop gain, A_V is given by:

$$A_V = -\frac{R^2}{R_2} \cdot \left(\frac{2}{R} + \frac{1}{R_1} \right)$$

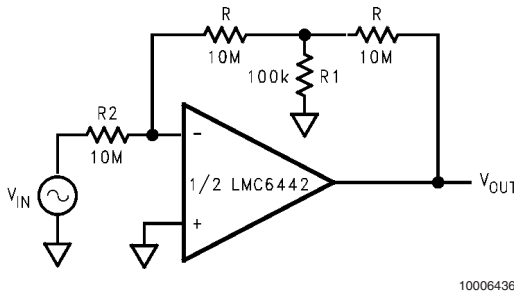

FIGURE 2. “T” Network Used to Replace High Value Resistor

It must be noted, however, that using this scheme, the realizable bandwidth would be less than the theoretical maximum. With feedback factor, β , defined as:

$$\beta \approx \frac{R_2}{R_2 + R} \cdot \frac{R_1}{R_1 + R} \text{ for } R_2 \gg R_1$$

$$BW(-3 \text{ dB}) \approx GBWP \cdot \beta$$

In this case, assuming a GBWP of about 10 KHz, the expected BW would be around 50 Hz (vs. 100 Hz with the conventional inverting amplifier).

Looking at the problem from a different view, with R_F defined by $A_V \cdot R_{in}$, one could select a value for R in the “T” Network and then determine R1 based on this selection:

$$R_1 = \frac{R^2}{R_F - 2R}$$

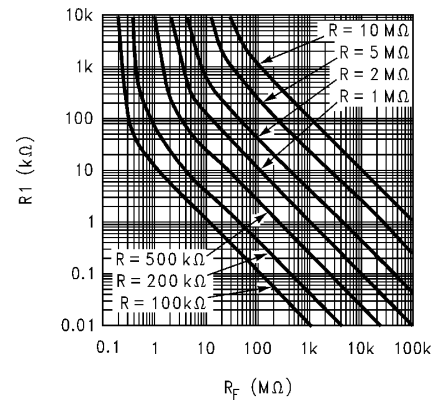

FIGURE 3. “T” Network Values for Various Values of R

For convenience, *Figure 3* shows R1 vs. R_F for different values of R.

DESIGN CONSIDERATIONS FOR CAPACITIVE LOADS

As with many other opamps, the LMC6442 is more stable at higher closed loop gains when driving a capacitive load. *Figure 4* shows minimum closed loop gain versus load capacitance, to achieve less than 10% overshoot in the output small signal response. In addition, the LMC6442 is more stable when it provides more output current to the load and when its output voltage does not swing close to V^- .

The LMC6442 is more tolerant to capacitive loads when the equivalent output load resistance is lowered or when output voltage is 1V or greater from the V^- supply. The capacitive load drive capability is also improved by adding an isolating resistor in series with the load and the output of the device. *Figure 5* shows the value of this resistor for various capacitive loads ($A_V = -1$), while limiting the output to less than 10 % overshoot.

Referring to the Typical Performance Characteristics plot of Phase Margin (Worst Case) vs. Supply Voltage, note that Phase Margin increases as the equivalent output load resistance is lowered. This plot shows the expected Phase Margin when the device output is very close to V^- , which is the least stable condition of operation. Comparing this Phase Margin value to the one read off the Open Loop Gain/Phase vs. Frequency plot, one can predict the improvement in

Applications Information (Continued)

Phase Margin if the output does not swing close to V^- . This dependence of Phase Margin on output voltage is minimized as long as the output load, R_L , is about $1M\Omega$ or less.

Output Phase Reversal: The LMC6442 is immune against this behavior even when the input voltages exceed the common mode voltage range.

Output Time Delay: Due to the ultra low power consumption of the device, there could be as long as 2.5 ms of time delay from when power is applied to when the device output reaches its final value.

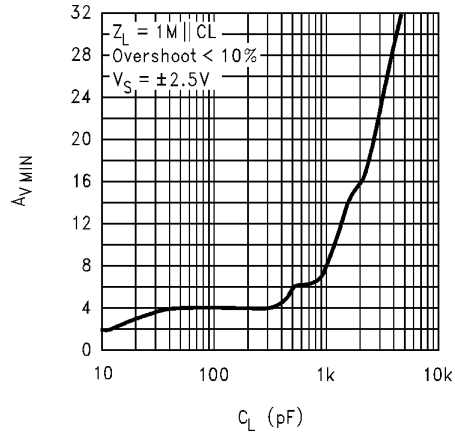

10006447

FIGURE 4. Minimum Operating Gain vs. Capacitive Load

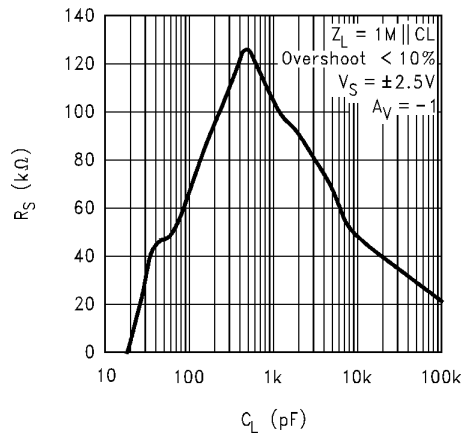

10006443

FIGURE 5. Isolating Resistor Value vs. Capacitive Load

Application Circuits

Micropower Single Supply Voltage to Frequency Converter

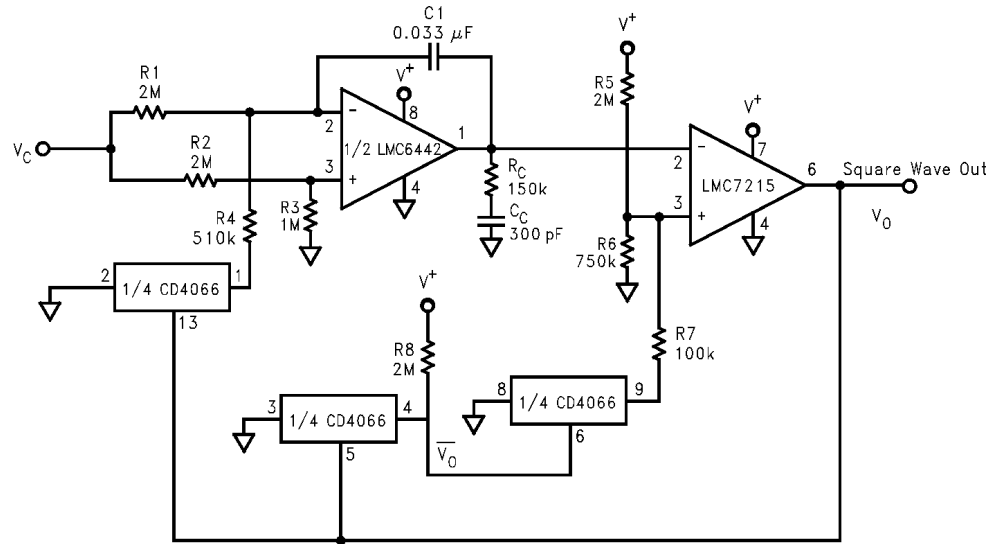

$V^+ = 5V$; $I_S < 10 \mu A$, $f/V_C = 4.3 (Hz/V)$

10006445

$$R1 \cong 4R4$$

$$R2 = 2R3$$

$$f(Hz) = \frac{V_C}{3R_1C_1V^+ \left[\frac{R_6}{R_5+R_6} - \frac{(R_6 \parallel R_7)}{(R_6 \parallel R_7)+R_5} \right]} \cong \frac{V_C(R_5+R_6)}{3R_1C_1V^+(R_6-R_7)} \text{ for } R_5 \gg R_6 \text{ and } R_6 \gg R_7$$

10006446

Gain Stage with Current Boosting

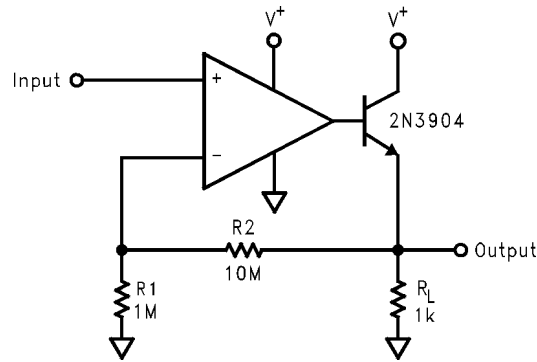

10006454

Application Circuits (Continued)

Offset Nulling Schemes

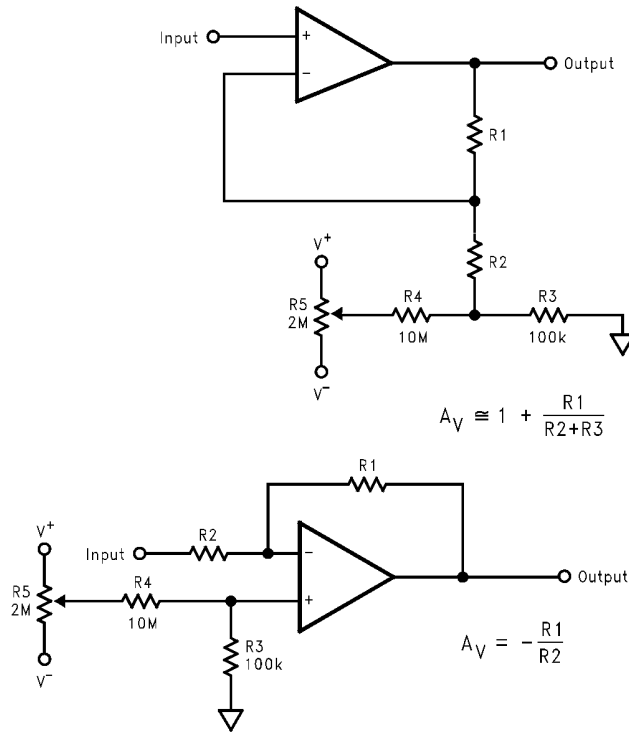

10006444

Ordering Information

Package	Temperature Range		Package Marking	Transport Media	NSC Drawing
	Industrial -40°C to +85°C	Military -55°C to +125°C			
8-Pin SOIC	LMC6442AIM	—	LMC6442AIM	Rails	M08A
	LMC6442AIMX			2.5k Tape and Reel	
	LMC6442IM	—	LMC6442IM	Rails	
	LMC6442IMX			2.5k Tape and Reel	
8-Pin DIP	LMC6442IN	—	LMC6442IN	Rails	N08E
8-Pin CDIP	—	5962-9761301QPA	LMC6442AMJ-QML 5962-9761301QPA	Rails	J08A
10-Pin SOIC	—	5962-9761301QXA	LMC6442AMWG-Q 9761301QXA	Trays	WG10A

Physical Dimensions inches (millimeters)
 unless otherwise noted

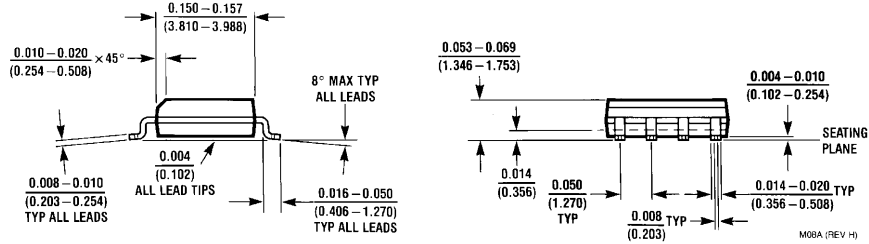
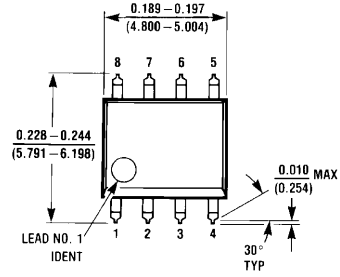

**8-Lead (0.150" Wide) Molded Small Outline Package, JEDEC
 NS Package Number M08A**

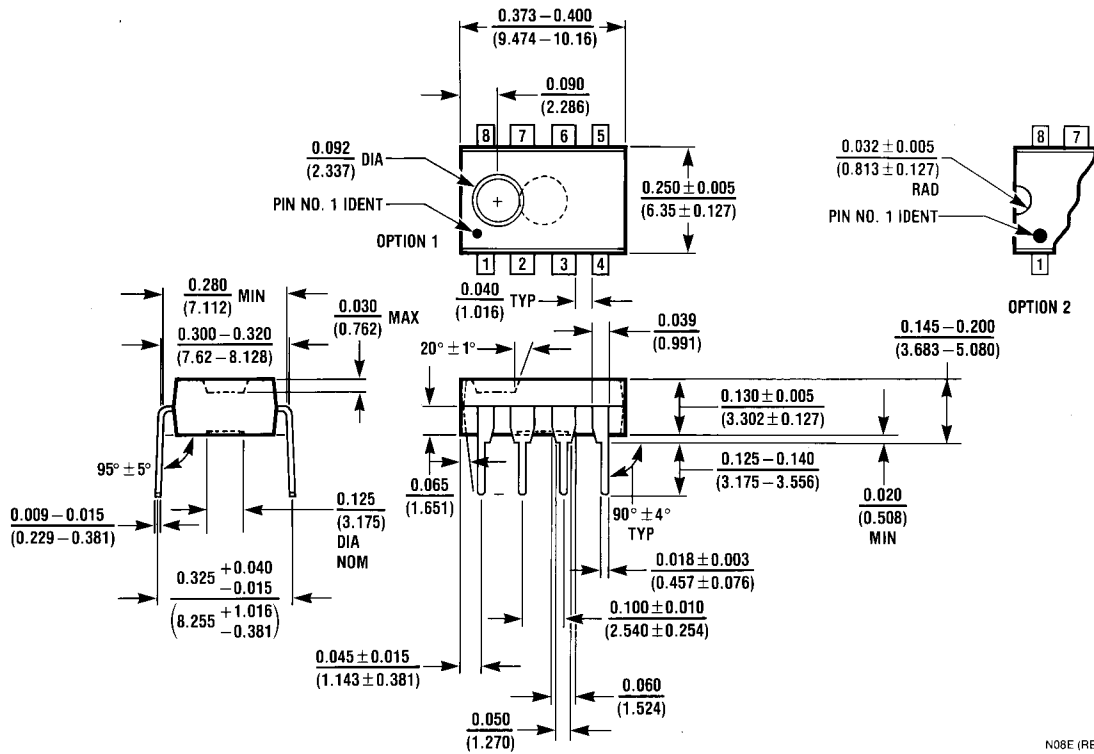

**8-Lead (0.300" Wide) Molded Dual-In-Line Package
 NS Package Number N08E**

Notes

National does not assume any responsibility for use of any circuitry described, no circuit patent licenses are implied and National reserves the right at any time without notice to change said circuitry and specifications.

For the most current product information visit us at www.national.com.

LIFE SUPPORT POLICY

NATIONAL'S PRODUCTS ARE NOT AUTHORIZED FOR USE AS CRITICAL COMPONENTS IN LIFE SUPPORT DEVICES OR SYSTEMS WITHOUT THE EXPRESS WRITTEN APPROVAL OF THE PRESIDENT AND GENERAL COUNSEL OF NATIONAL SEMICONDUCTOR CORPORATION. As used herein:

1. Life support devices or systems are devices or systems which, (a) are intended for surgical implant into the body, or (b) support or sustain life, and whose failure to perform when properly used in accordance with instructions for use provided in the labeling, can be reasonably expected to result in a significant injury to the user.
2. A critical component is any component of a life support device or system whose failure to perform can be reasonably expected to cause the failure of the life support device or system, or to affect its safety or effectiveness.

BANNED SUBSTANCE COMPLIANCE

National Semiconductor manufactures products and uses packing materials that meet the provisions of the Customer Products Stewardship Specification (CSP-9-111C2) and the Banned Substances and Materials of Interest Specification (CSP-9-111S2) and contain no "Banned Substances" as defined in CSP-9-111S2.



National Semiconductor
Americas Customer
Support Center
Email: new.feedback@nsc.com
Tel: 1-800-272-9959

National Semiconductor
Europe Customer Support Center
Fax: +49 (0) 180-530 85 86
Email: europe.support@nsc.com
Deutsch Tel: +49 (0) 69 9508 6208
English Tel: +44 (0) 870 24 0 2171
Français Tel: +33 (0) 1 41 91 8790

National Semiconductor
Asia Pacific Customer
Support Center
Email: ap.support@nsc.com

National Semiconductor
Japan Customer Support Center
Fax: 81-3-5639-7507
Email: jpn.feedback@nsc.com
Tel: 81-3-5639-7560