

Using the EVAL-ADXL362Z-DB for System Solution Develop and Verification

FEATURES

USB/Coin Cell/External single supply +3V operation
Datatlogs onto MicroSD card
Real time data/SD card data logger/Inclinometer demo
user interface
Motion switch example code
70mm x 45mm small size

ONLINE RESOURCES

Evaluation Kit Contents

CD
[EVAL-ADXL362Z-DB](#)
MicroSD Card
USB Cable
Coin Cell

Documents Needed

[ADXL362](#) datasheet
RL78/G13 datasheet
DA8521 datasheet
Eink Application Note, Waveform Driving Schemes for
SURF ePaper Displays

Required Software

[ADXL362 DB GUI](#)

Design and Integration Files

[Schematics, layout files, bill of materials](#)

EQUIPMENT NEEDED

Multimeter / amperemeter
High capacity portable cell (3V, 0.5A)
PC running Windows
USB 2.0 port

GENERAL DESCRIPTION

This user guide describes the ADXL362 development board, the EVAL-ADXL362Z-DB, which provides an ultra low power portable system solution platform for various motion detection that can be duplicated in the final application. The development board can be configured as a data logger to gather data for algorithm developing. External 3V supply connector is left for user, high capacity AAA batteries or lithium thin cell can be used to power the development board, and thus it integrates seamlessly into portable applications. High capacity cell is used to provide continuous heavy current drawing by saving data in MicroSD. Additionally, the development board has an eink display and user can show the algorithm result on it in portable applications to verify the final performance, coin cell is more than enough to support the accelerometer, MCU and eink display together. The application software used to interface with the devices is also described.

TYPICAL SETUP

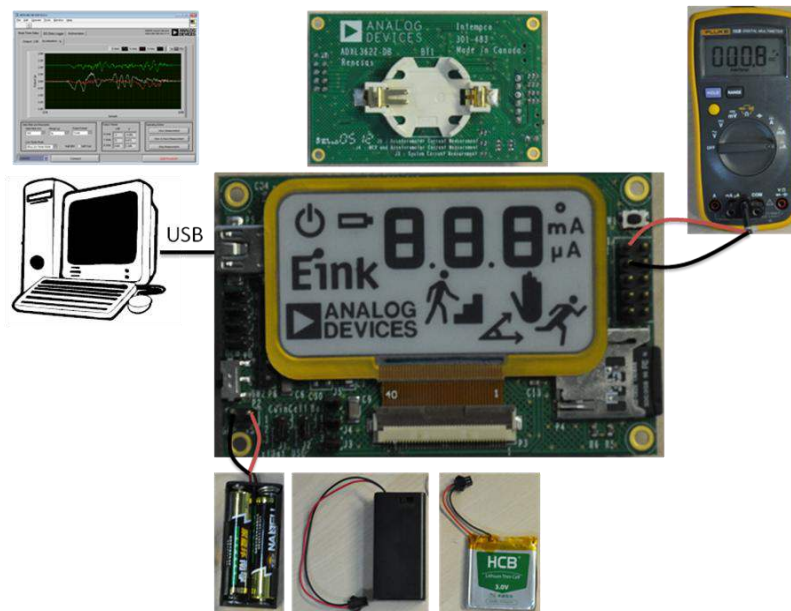

Figure 1. EVAL-ADXL362Z-DB Various Connection for Different Purposes



Evaluation Board User Guide

EVAL-ADXL362Z-DB

One Technology Way • P.O. Box 9106 • Norwood, MA 02062-9106, U.S.A. • Tel: 781.329.4700 • Fax: 781.461.3113 •
www.analog.com

Using the EVAL-ADXL362Z-DB for System Solution Develop and Verification

TABLE OF CONTENTS

Features	1	Evaluation Board Hardware	12
Online Resources	1	Jumper Settings	13
Equipment Needed	1	Evaluation Board Circuitry	13
General Description.....	1	Accelerometer	13
Revision History.....	2	Display	13
Getting Started.....	3	Display Driver	13
Software Installation Procedures	3		
Development Board Setup Procedures	7		

REVISION HISTORY

8/12—Revision 0: Initial Version

GETTING STARTED

This section provides quick start procedures for using [EVAL-ADXL362Z-DB](#) board. Both the default and optional settings are described.

SOFTWARE INSTALLATION PROCEDURES

Install USB Drivers

To install the USB drivers, follow these steps:

1. Download and unzip *VCOMUSBdriver_V2040a_32bit.zip* or *VCOMUSBdriver_V2040a_64bit.zip* according to your PC OS from CD or website to the PC hard drive.
2. Connect the development board to the computer via the included USB cable.
3. If prompted to install drivers, click **Install from a list or specific location (Advanced)** (See Figure 2); then click **Next**.



Figure 2. Found New Hardware Prompt

4. Select **Don't search. I will choose the driver to install** (See Figure 3), and click **Next**.

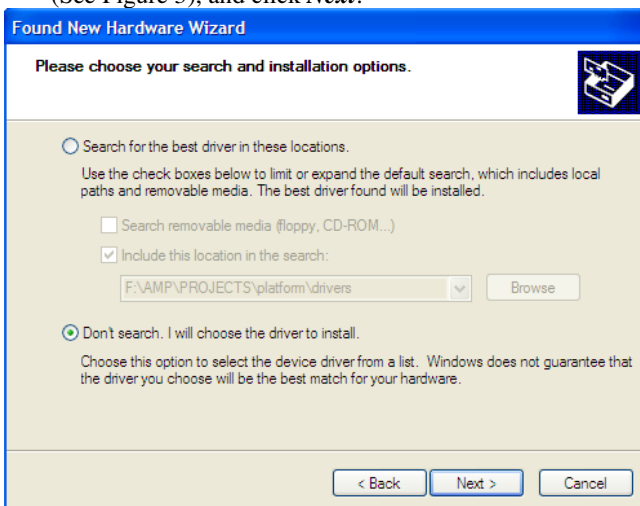

Figure 3. Search and Installation Options

5. Select **Ports (COM & LPT)** (See Figure 4), and click **Next**.

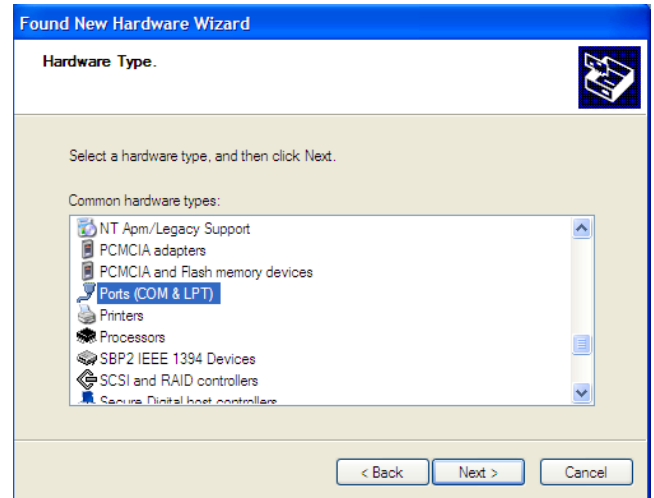

Figure 4. Select Hardware Type

6. Click **Have Disk...** (See Figure 5) to select the device driver.

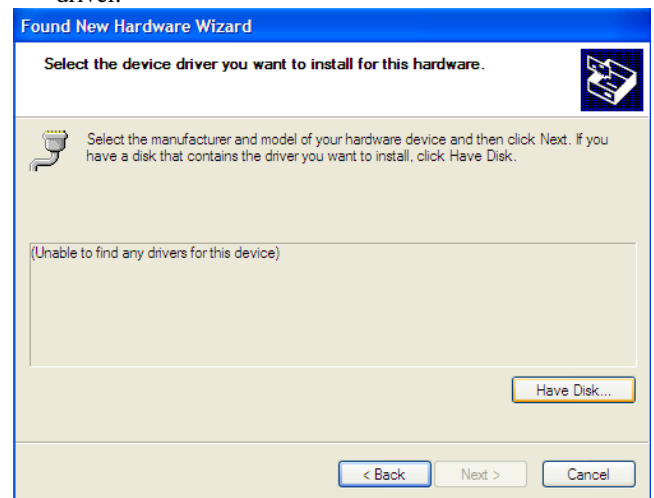

Figure 5. Select Hardware Driver

7. Select **Browse...** to find driver on PC hard drive.

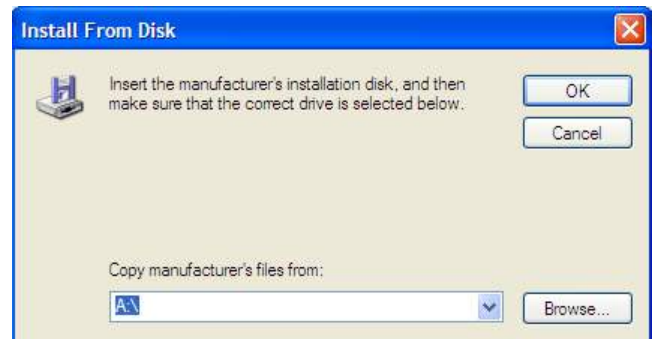

Figure 6. Install From Disk

8. Find **MQB2SALL.inf** in *VCOMUSBdriver_V2040a_32bit* or *VCOMUSBdriver_V2040a_64bit* according to your PC OS, select it and click **Open** (See Figure 7).

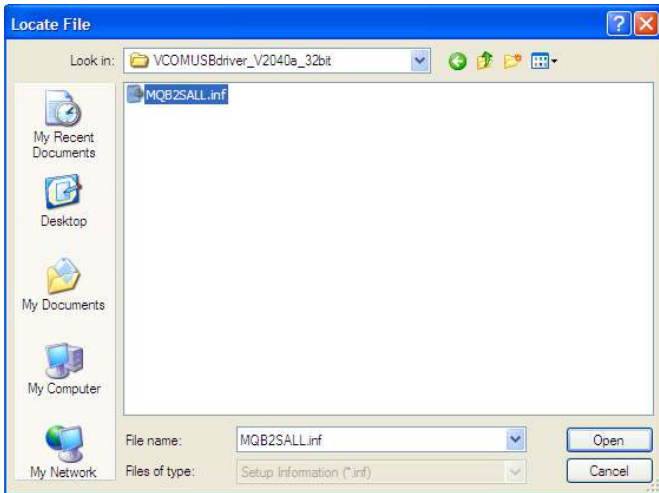

Figure 7. Open Hardware Driver

9. Then, it will go back to Install From Disk interface (See Figure 8), click **OK**.

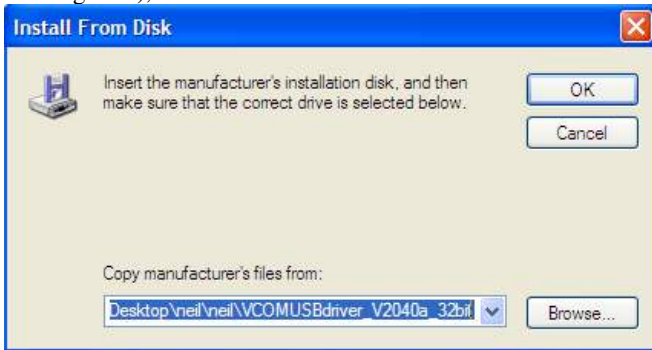

Figure 8. Confirm Hardware Driver

10. Select **ADI Inertial Sensor Development Board** from the model list (See Figure 9), and click **Next** to complete the process.

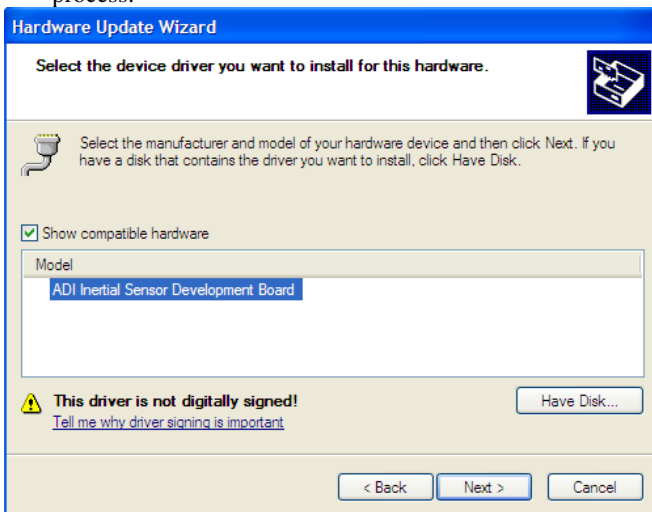

Figure 9. Select ADI Inertial Sensor Development Board Drivers

11. Select Continue Anyway when you get the warning as Figure 10 shows.

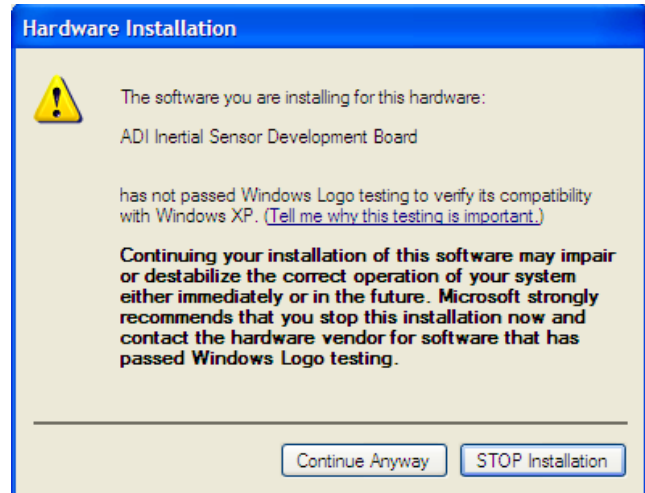

Figure 10. Continue Installation

12. Click **Finish** to complete the USB driver installation as Figure 11 shows.

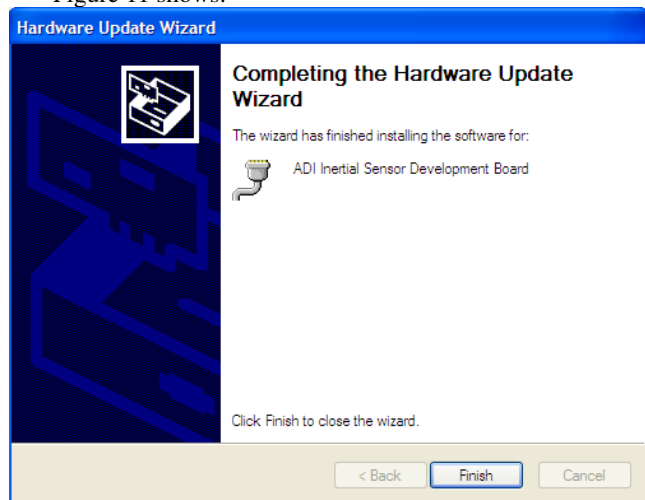

Figure 11. Finish Driver Installation

COM PORT VERIFICATION

After installing the USB driver, please check the communication port that is assigned to the development board. Install firmware onto the microcontroller, as well as operating the ADXL362 DB GUI, requires that you know the assigned COM port number. Please perform the following steps to check.

For Windows 7/Vista,

1. From the **Start** menu, right click **My Computer** and select **Properties**.
2. In the upper left corner of the window that opens, select **Device Manger**, shown in Figure 12. Windows 7 may request that you allow access to this panel.
3. Expand the **Ports (COM & LTP)** menu item. **ADI Inertial Sensor Development Board** should be listed with an assigned COM port number in parenthesis (See Figure 13).
4. Note the COM port number for future use.

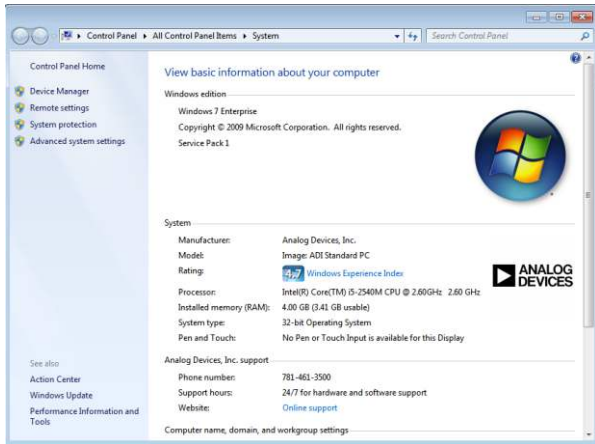

Figure 12. Windows 7 System Properties

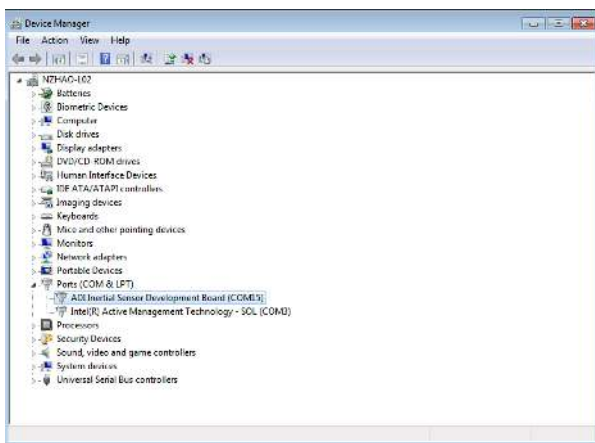

Figure 13. Device Manager Showing the COM Port Number

For Windows XP/2000,

1. From the **Start** menu, right click **My Computer** and select **Properties**.
2. Click the **Hardware** tab of the **System Properties** window, as shown in Figure 14. **Error! Reference source not found..**
3. Select **Device Manager** to look up the assigned COM port of the ISEB hardware.

The **Device Manager** window should look like the window shown in Figure 13.



Figure 14. Windows XP System Properties

Install Firmware

Different firmware is included on the CD and website for customer to evaluate different functions. To flash a new version of the firmware onto the development board microcontroller, please follow these steps:

1. Download flash programmer from CD or website, http://am.renesas.com/products/tools/flash_prom_programming/rfp/downloads.jsp and install it on the PC.
2. Run Renesas Flash Programmer V1.03, select **Create new workspace** if you use it for the first time and click **Next** (See Figure 15). If you are debugging a project by yourself and would like to update firmware without changing the project storage path, then you can select **Open latest workspace** to faster process flow since the programmer can remember the latest configuration.

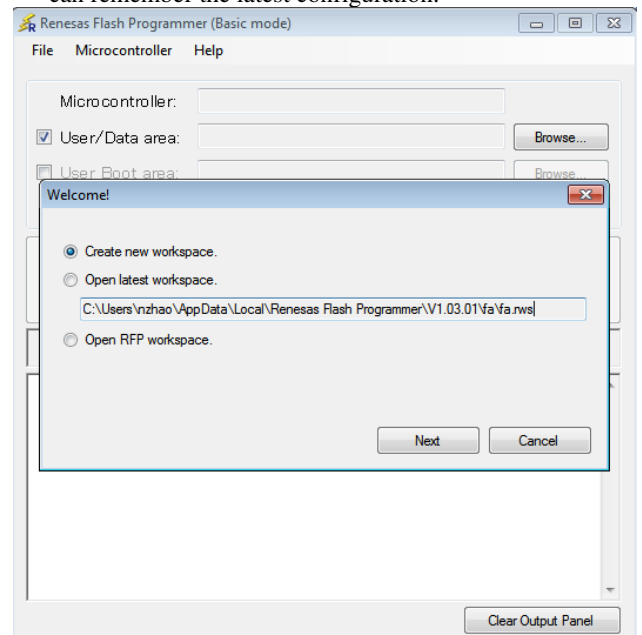

Figure 15. Microcontroller Programmer Startup

3. Select **RL78** in **Microcontroller:** drop-down menu, input **RL78/G13** (case-insensitive) in **Filter:** textbox, roll the scrollbar to find the Device Name: **R5F100LJ** in the **Using Target Microcontroller**, Input workspace name in the **Workspace Name:** textbox (See Figure 16), then click **Next**.

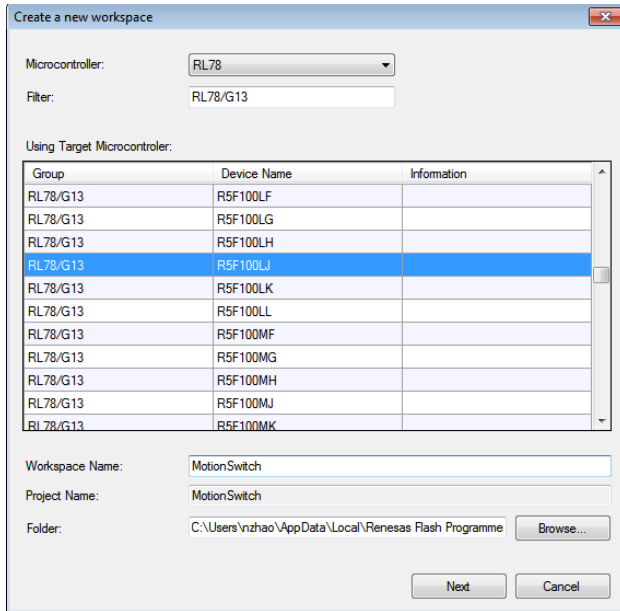

Figure 16. Select Target Microcontroller

4. Select assigned COM port number for development board in **Select Tool:** drop-down menu (See Figure 17), and click **Next**.

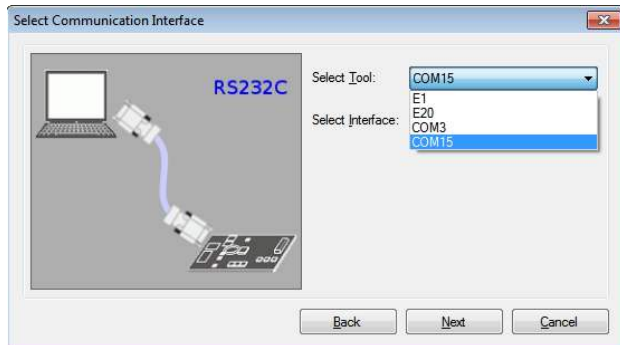

Figure 17. Select Com Port

5. Keep the default setting for power supply and click **Next** (See Figure 18).

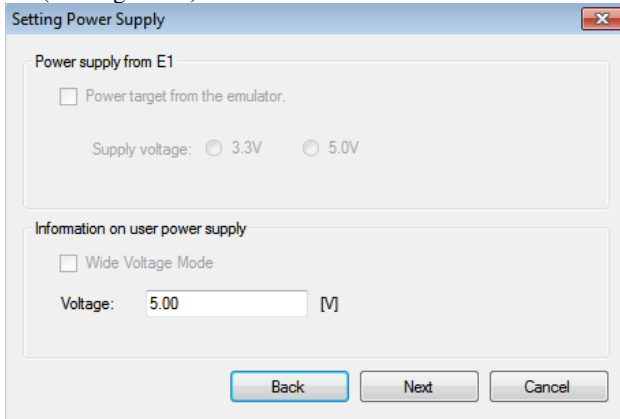

Figure 18. Setting Power Supply

6. Check Information Settings and click **Complete** (See Figure 19).

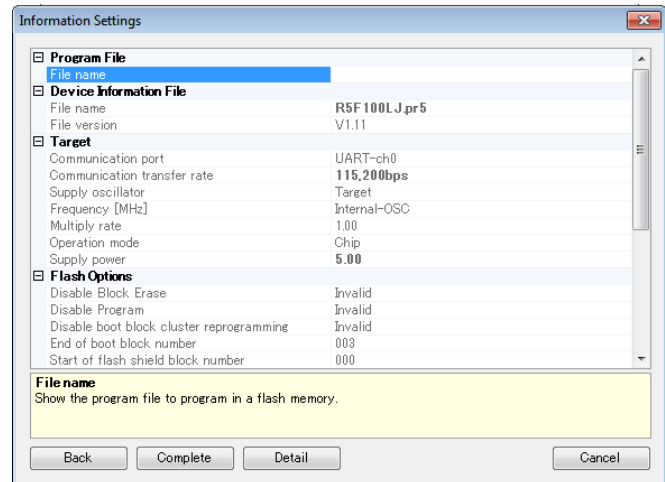

Figure 19. Information Settings

7. Click **Browse...** to find the .hex file that going to be downloaded and then click **Start** (See Figure 20).

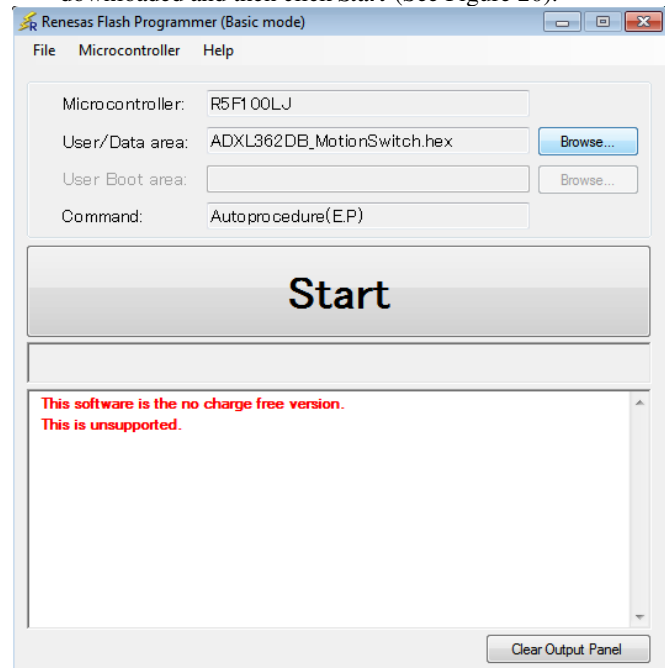

Figure 20. Select Firmware

8. Wait for programming code flash, you will get the interface as shown in Figure 21 after a while. Close the Renesas Flash Programmer to finish the firmware installation.

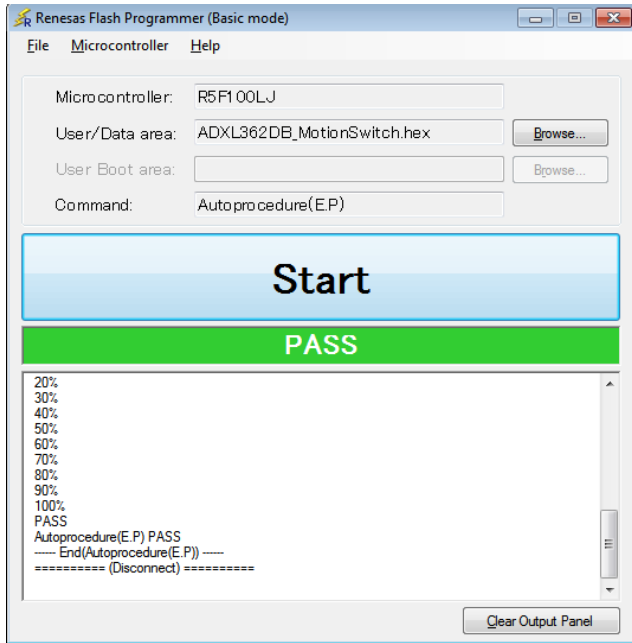

Figure 21. Install Firmware Success

Install ADXL362 Development Board GUI

The software GUI installation has been created to include any required National Instruments drivers and run-time engines that are necessary for proper operation. To run the software GUI installation routine, double-click the **setup.exe** file located in the **/ADXL362 DB GUI Installer/** folder on the included CD. Windows 7 may request that you allow access to this software. Then, the window shown in Figure 22 is displayed.

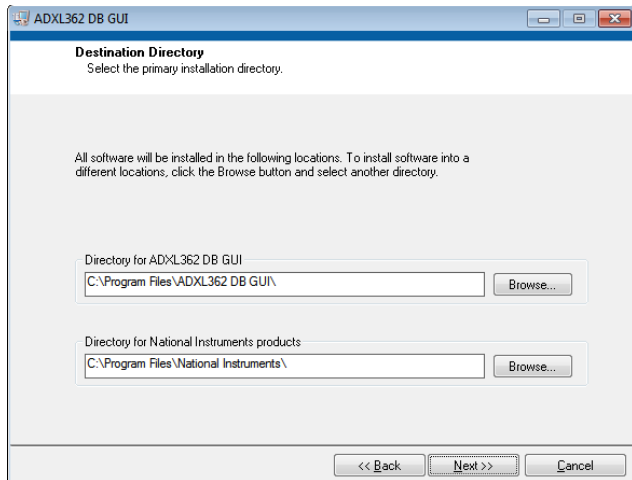

Figure 22. Destination Directory Selection

From this point, complete the following steps to install the ADXL362 development board GUI:

1. Select the destination directory. The installer autopopulates the names of the directories in which to store the software GUI and required National Instruments products (See Figure 22). You can change these directories; however, most installations can proceed with the default values.
2. When you finish selecting a directory, click **Next**.

3. The installer lists the required components to install on your PC (See Figure 23).
4. To start the installation, click **Next**. The installer completes installation of the software evaluation GUI and all required National Instruments drivers and run-time engines. After the installation is complete, the box shown in Figure 24 is displayed.
5. Click **Finish** to complete the installation. Then, a shortcut to launch the executable is added to the **Desktop** and also **All Programs -> Analog Devices – Inertial Sensor Eval -> ADXL362 DB GUI**

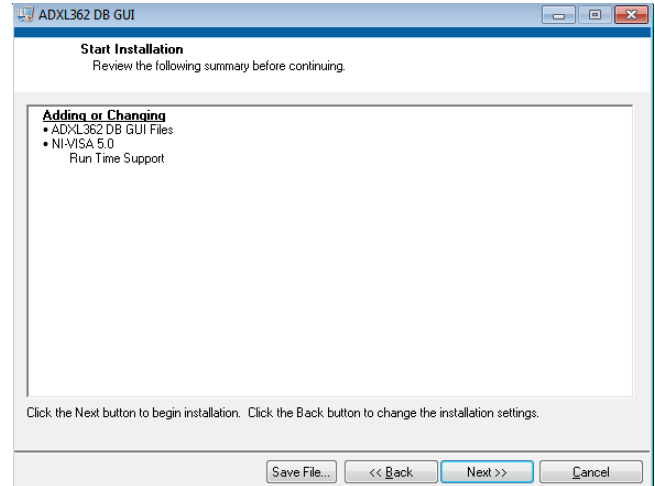

Figure 23. Start Installation (Listing Varies Based on PC Requirements)

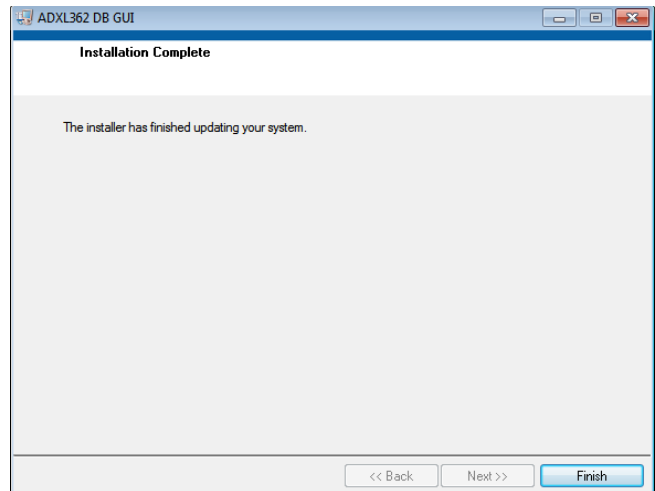

Figure 24. ADXL362 DB GUI Installation Complete

DEVELOPMENT BOARD SETUP PROCEDURES

Before using the ADXL362 development board for testing, please make clear the firmware in microcontroller. It is motion switch demo in default.

Motion Switch Demo

To evaluate motion switch function, please follow these steps:

1. Verify that the jumpers are configured as shown in Figure 25. Take off jumpers on J6-J9 for microcontroller normal operation if you want to test system current consumption with coin cell power supply. You can also configure the

jumpers of J6-J9 at position 2-3 for virtual COM, just the current consumption is a little higher.

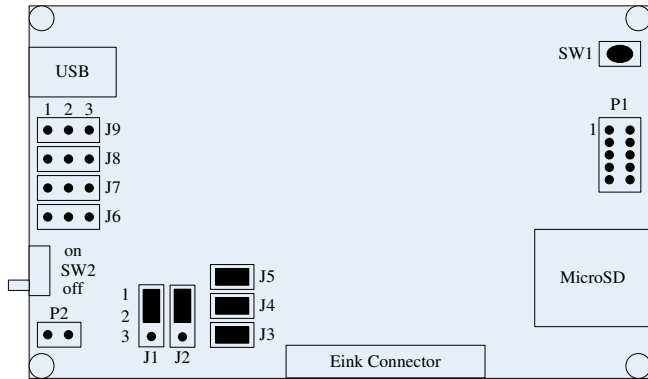

Figure 25. Correct Jumper Positions for Motion Switch Demo with Coin Cell Supply

2. Insert eink display into E Ink Connector.
3. Insert coin cell into coin cell socket at bottom side.
4. Turn on the SW2.
5. You will see the E Ink display will flash black, white and then turn on all the icons.
6. If you make the development board in stable conditions and last for 3.2 seconds, all the icons will be turned off except the “Analog Devices and E Ink” logo and “power on” icon.
7. If you move or shake the board, all the icons will be turned on again.
8. To detect the system current consumption (eink display + MCU + ADXL362), it is recommended to turn off SW2, remove the jumper link from the connector J3 and replace it with the two leads of a multi-meter/ ampere-meter, then turn on SW2. If the space of J3 is too limited for two leads, you can also connect the two leads of a multi-meter/ ampere-meter with pin1 and pin3 of P1. Figure 26 shows the eink display and system current consumption when the development board is in inactivity status.



Figure 26. EVAL-ADXL362Z-DB in Inactivity Status

9. Figure 27 shows the eink display and system current consumption when you keep on moving or shaking the development board to make it in activity status.



Figure 27. EVAL-ADXL362Z-DB in Activity Status

10. To detect MCU + ADXL362 current consumption, it is recommended to turn off SW2, remove the jumper link from the connector J4 and replace it with the two leads of a multi-meter/ ampere-meter, then turn on SW2. If the space of J4 is too limited for two leads, you can also connect the two leads of a multi-meter/ ampere-meter with pin3 and pin5 of P1.
11. To detect ADXL362 itself current consumption, it is recommended to turn off SW2, remove the jumper link from the connector J5 and replace it with the two leads of a multi-meter/ ampere-meter, then turn on SW2. If the space of J5 is too limited for two leads, you can also connect the two leads of a multi-meter/ ampere-meter with pin5 and pin7 of P1.

Real Time Data / SD Data Logger / Inclinometer Demo

To evaluate the optional ADXL362 real time output, SD data logger and inclinometer demo, please follow these steps:

1. Configure the jumpers as shown in Figure 28 for installing firmware.

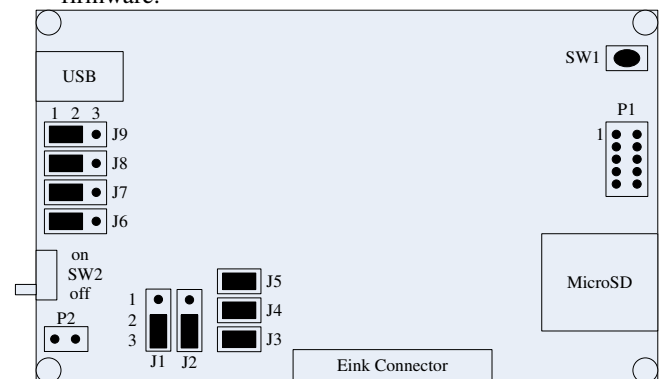

Figure 28. Correct Jumper Positions for Installing Firmware

2. Insert eink display into E Ink Connector.

3. Insert MicroSD into SD card slot.
4. Connect development board with PC through USB cable.
5. Install *ADXL362DB_Firmware.hex* into microcontroller as described in *Install Firmware* section.
6. Disconnect USB cable, configure the jumpers as shown in Figure 29 for virtual COM.

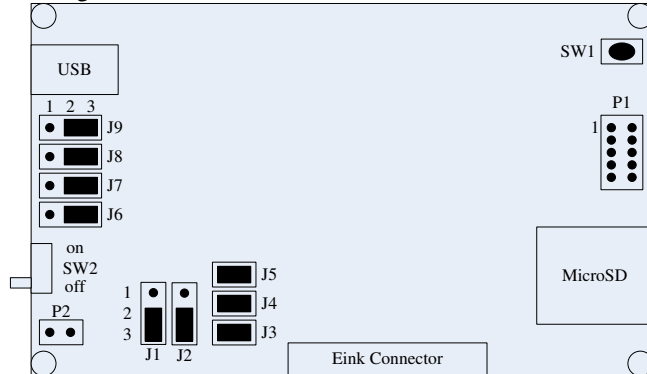

Figure 29. Correct Jumper Positions for Virtual Com

7. Connect development board with PC through USB cable. Now, the development board can enter different work mode based on customer operations. If you duplicate the motion: *move / tap / shake / rotate the development board to generate activity interrupt -> make the development board stable around two seconds to generate inactivity interrupt* three times, the development board will go into SD card data logger mode. Please note that activity and inactivity should always happen in serials and activity should always happen before inactivity. Eink display will give indications during your operations. At the digit unit position, it will show the activity interrupt times. At the digit hundred position, it will show the inactivity interrupt times. Figure 30 shows the eink display when the development board get the first inactivity interrupt after the first activity interrupt.



Figure 30. E-ink Display for First Inactivity Interrupt

8. Figure 31 shows the eink display when the development board get the second inactivity interrupt after the second activity interrupt.



Figure 31. E-ink Display for Second Inactivity Interrupt

9. When the development board get the third inactivity interrupt after the third activity interrupt, it will start to check whether the hardware configuration is OK for data logger. Figure 32 shows the hardware configuration is OK for data logger and the development board has entered into data logger mode. Figure 33 shows there is something wrong with hardware configuration for data logger, such as forget to insert SD card, SD card is broken or the supply current is not enough when using a dying external battery. For a new SD card, if you never configure it through ADXL362 DB GUI, it will save ADXL362 output in 2g measurement range and 50Hz output data rate.



Figure 32. E-ink Display for Entered Into Data Logger Mode



Figure 33. Display Bad Configuration for Data Logger

10. Once development board entered into data logger mode successfully, it won't receive any instructions from ADXL362 DB GUI. If you run the GUI before development board enter into data logger mode, it won't judge activity and inactivity interrupt anymore. It is recommended to configure SD data logger parameter before saving data with it. To configure data logger parameter, run ADXL362 DB GUI after connecting the

development board with PC through USB. A window similar to the one shown in Figure 34 is displayed. At this point, the functionality of the GUI is completely deactivated. You need to select assigned COM port number for development board as shown in Figure 34, and click **Connect**.

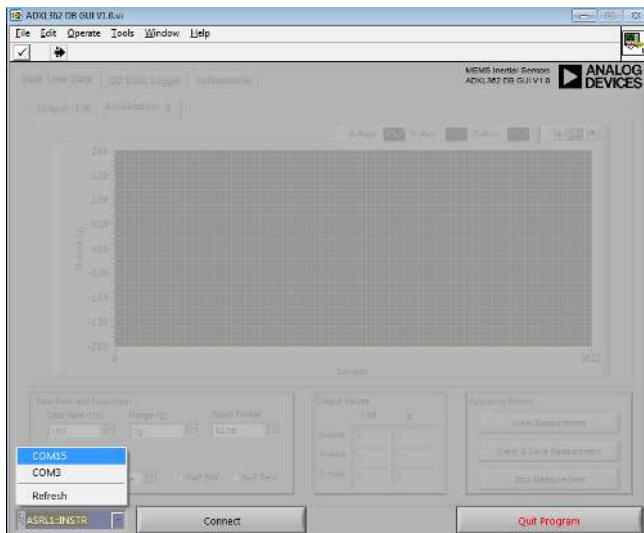

Figure 34. ADXL362 DB GUI Startup

- After the COM port is connected, the full functionality of the GUI is available for you to use. Note that you should not press the reset button (SW1) while the GUI is running. This causes the development board and the GUI to lose sync and also causes the evaluation system to no longer function properly. Additionally, if for any reason the development board and the GUI do not appear to be properly communicating, you should close the GUI by clicking the **Quit Program**, reset microcontroller by pressing SW1 and then restart the GUI.
- Go to **SD Data Logger** tab, you can configure ADXL362 output data rate (SD data logger frequency is based on this), measurement range, different work mode for power/noise tradeoff, internal low-pass filter pole and self test. After selection, please click **Configure** button in **Data Logger Parameters Configuration** section, if there is no problem with hardware configuration, Figure 35 will be shown. If there is something wrong with the SD card, it will give the warning message to let you check SD card.

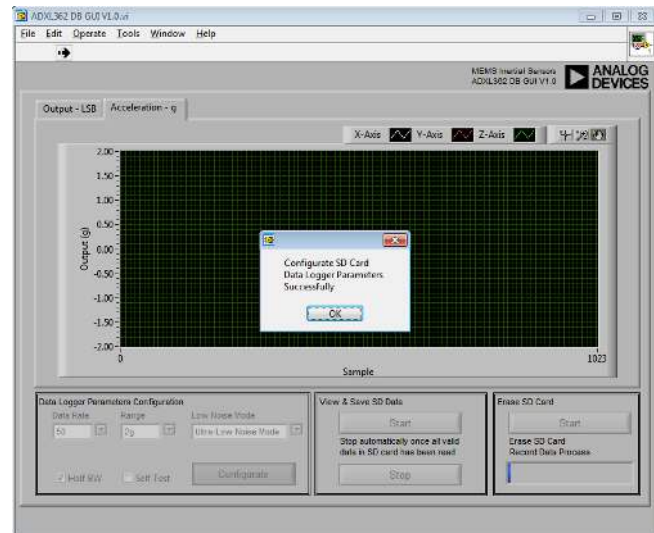

Figure 35. Configure SD Card Data Logger Parameters Successfully

- The saved data on SD card can be viewed and saved to PC by clicking **Start** button in **View & Save SD Data** section. This causes many of the options and tabs to be grayed out or to disappear, to prevent software conflicts, until all valid data in SD card has been read or the **Stop** button in **View & Save SD Data** section is clicked. The saved acceleration data on SD card then begins to flow across the screen (See Figure 36).

At the same time, it allows you to continuously stream the data to eleven .txt file. The first .txt file is named and located by user, the other ten .txt files are named based on the first .txt file and located in the same folder.

Eg: If user named DataloggerTest.txt in pop-up dialog box and saved it on desktop, then other ten .txt files which named DataloggerTest_1.txt, DataloggerTest_2.txt, ... DataloggerTest_10.txt will be built automatically on desktop. Once SDDataloggerTest.txt saved 64K samples, the following data will be saved in DataloggerTest_1.txt, the rest can be deduced by analogy. When go to the last file DataloggerTest_10.txt, the data will be saved continuously even its size is bigger than 64K samples. If the samples saved in SD card is smaller than 64K, then the files without any data saved will be deleted automatically when all valid data in SD card has been read or the **Stop** button in **View & Save SD Data** section is clicked.

Each .txt file created contains a header with the date, time, X, Y, Z axes acceleration data, in g, are aligned in tab-delimited columns.

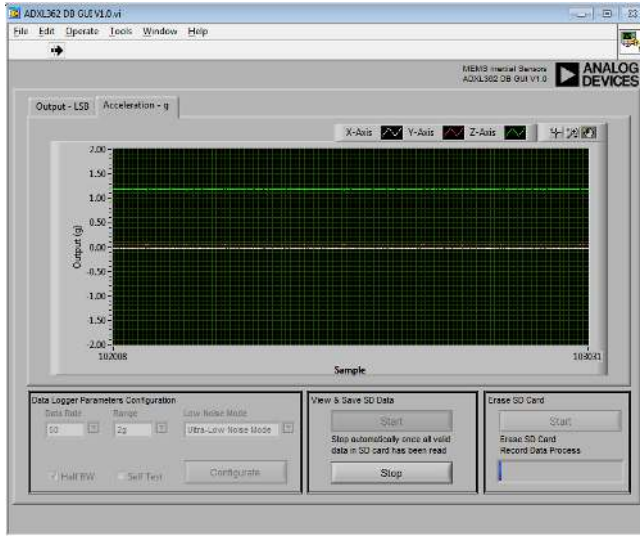

Figure 36. View and Save SD Card Data on PC

- After view and save SD Card data on PC, it is recommended to erase SD Card for saving data the next time. To erase SD Card, click **Start** in **Erase SD Card** section. Progress bar in Erase SD Card section will show the erase process. It needs around 30ms to erase 256 x 512 bytes data, if there are 1GB valid data saved in SD card, it may need around four minutes to erase. Of course, it needs very long time to save 1GB data. Suppose the output data rate of ADXL362 is 100Hz, it needs to save data continuously around 21 days to generate 1GB 3-axes acceleration data. Figure 37 shows picture once SD card is erased successfully. If there is something wrong with the SD card, it will give the warning message to let you check SD card.

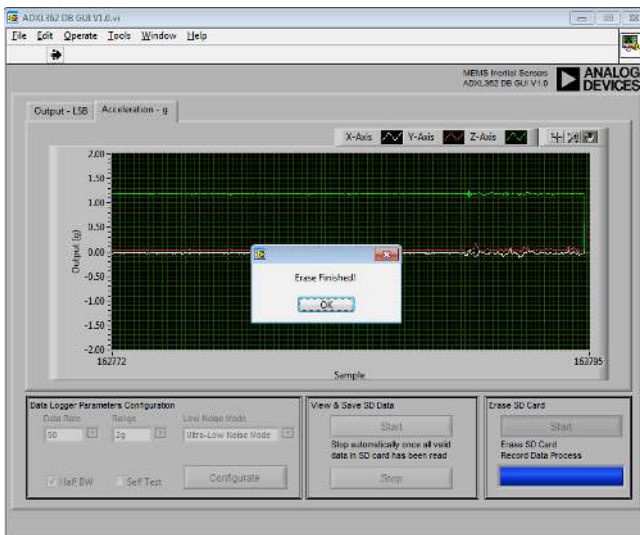

Figure 37. Erase Finished and Successfully

- ADXL362 DB GUI also support viewing and saving unlimited ADXL362 Real Time Data for algorithm developing and noise analysis, also sensor performance study. Go to **Real Time Data** tab, it contains an oscilloscope-like interface used to view the output of the accelerometer and parameters configuration function, such

as output data rate, measurement range, output format, different work mode for power/noise tradeoff, internal low-pass filter pole and Self Test (See Figure 38).

After configuration, you can begin real-time measurement by clicking the **View Measurement**. This causes many of the options and tabs to be grayed out or to disappear, to prevent software conflicts, until the **Stop Measurement** button is clicked. The accelerometer output data then begins to flow across the screen.

View & Save Measurement performs the same basic function as **View & Save SD Data** which is introduced in item 13.

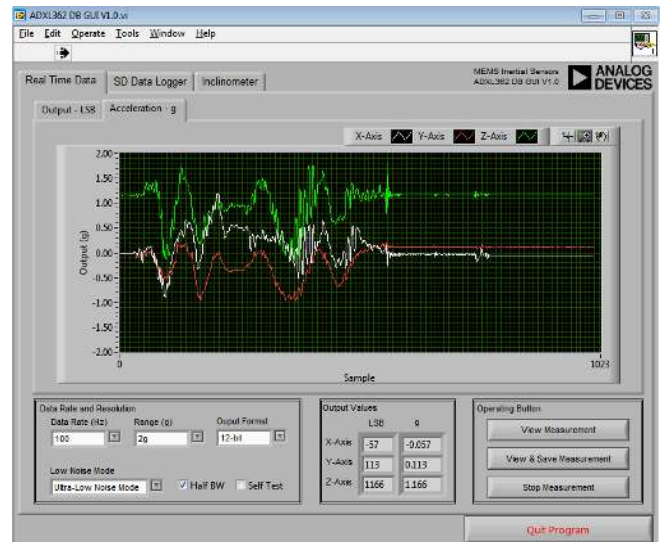

Figure 38. Real Time Data Tab

- ADXL362 DB GUI also support inclinometer demo. Go to **Inclinometer** tab, read the notes firstly. Then, put the development board on table flatly to make it parallel with the ground (z axis in 1g field), click **Offset Calibration** button, wait around 10 seconds to finish offset calibration. After that, click **Start Tilt Sensing** button to test the development board tilt angle (please try to make z axis in 0g filed when playing tilt sensing). You can click **Stop Tilt Sensing** button to stop tilt sensing function at any time (See Figure 39).

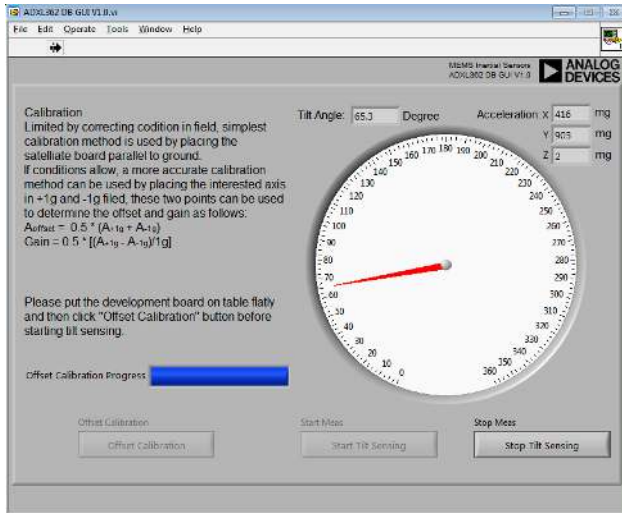

Figure 39. Inclinometer Demo

- It is recommended to power development board through USB as described in Figure 29 when evaluating ADXL362Z-DB GUI. For data logger, it is recommended to use high capacity AAA batteries or lithium thin cell to power the development board, and thus it integrates seamlessly into portable applications as shown in Figure 40.



Figure 40. Data Logger with Portable Supply

- Figure 41 shows correct jumper positions for powering development board with external portable supply for data logger function. SW2 is also used to control the on/off for external supply.

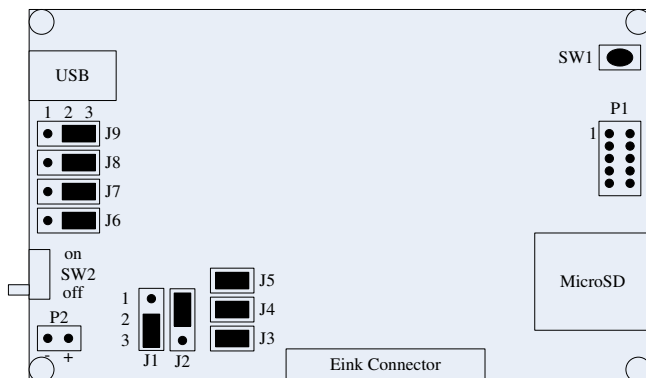

Figure 41. Correct Jumper Positions for External Supply

EVALUATION BOARD HARDWARE

The EVAL-ADXL362Z-DB provides a hardware platform for system solution develop and verification. Figure 1 shows EVAL-ADXL362Z-DB various connection for different purposes.

Firstly, the EVAL-ADXL362Z-DB could be configured as a portable data logger to save essentially unlimited acceleration data onto a MicroSD. User can select different acceleration output data rate, measurement range, etc. based on different applications to save. These raw data can be used for refining algorithms, tuning thresholds, and generally familiarizing oneself with accelerometer data.

Secondly, the EVAL-ADXL362Z-DB could be used to verify user finalized solution. Take pedometer as an example, you can tie the development board on wrist/arm/ankle, hold in hand or put in pocket, then walk or run and show the steps on the eink display. You can check the solution accuracy intuitively. At the same time, you can check the current consumption of your solution with multi-meter. The development board offer three optional current: accelerometer itself, system current without display (accelerometer + microcontroller), system current with display (accelerometer + microcontroller + display) for measurement.

Thirdly, the EVAL-ADXL362Z-DB could be configured to communicate with PC. Then, user can view and save the real time output of ADXL362 on PC, configure data logger parameters and realize demo that does not have to be portable, like inclinometer.

POWER SUPPLIES

The EVAL-ADXL362Z-DB supports three kinds of power supply.

- USB, all kinds of functions can be supported by USB supply. When using USB supply, please make sure the jumper J2 is at 2-3 position as shown in Figure 29 (There are notes on PCB board). There is a 3V LDO ADP3338 on the board which will switch 5V input to 3V for the following circuits.
- Coin Cell, all the portable demo shows or user portable applications verification can be supported by coin cell. When using coin cell supply, please make sure the jumpers J1 and J2 is at 1-2 position as shown in Figure 25 (There are notes on PCB board). The following circuits are powered by coin cell output directly in default. Another optional supply path which go through low power LDO is also offered to user. To do this, remove 0 Ohm resistor R24, solder 1uF capacitor at C30 and C31 position, solder ADP160AUJZ-2.7-R7 at U9 position. The on/off of coin cell can be controlled by SW2.
- External 3V supply, this supply is recommended to use when realizing portable data logger function. High capacity AAA batteries or lithium thin cell as shown in Figure 1 is recommended to support continuous heavy current drawing when saving data in MicroSD. When using external supply, please make sure the jumper J1 is at 2-3 position and J2 is at 1-2 position as shown in Figure 41 (There are notes on PCB board). The on/off of external supply can be controlled by SW2.

JUMPER SETTINGS

Set the jumper settings/link options on the development board for the required operating modes before powering on the board. The functions of the jumpers are described in Table 1.

Table 1. Jumper Settings

Jumper	Description
J1	This jumper selects coin cell and external supply, position 1-2 for coin cell, position 2-3 for external supply.
J2	This jumper selects portable battery (coin cell and external supply) and USB supply, position 1-2 for battery, position 2-3 for USB supply.
J3	This jumper connects 3V input and following circuits (accelerometer + microcontroller + display), system current consumption with display can be tested by removing and replacing it with the two leads of a multi-meter/ ampere-meter.
J4	System current consumption without display (accelerometer + microcontroller) can be tested by removing and replacing J4 with the two leads of a multi-meter/ ampere-meter.
J5	Accelerometer ADXL362 current can be tested by removing and replacing J5 with the two leads of a multi-meter/ ampere-meter.
J6 - J9	These four jumpers are used to control the different operating modes of the microcontroller, position 1-2 for on-board debug/flash programming, position 2-3 for virtual UART.
P1	Extension interface, all kinds of development board current consumption can be tested and shown with another board based on this interface. Other sensors and analog input can also be connected to development board through P1.
P2	External 3V supply interface
P3	Eink display interface
P4	MicroSD interface
P5	USB interface
SW1	Microcontroller reset button
SW2	Battery switch

EVALUATION BOARD CIRCUITRY

This section describes the key parts on the development board.

ACCELEROMETER

The ADXL362 is an ultralow power, 3-axis MEMS accelerometer that consumes less than 2 uA at 100 Hz output data rate and 270 nA when in motion triggered wake-up mode.

MICROCONTROLLER

The microcontroller on EVAL-ADXL362Z-DB is RL78/G13 from Renesas. It is an ultralow power MCU that consumes around 4.6 mA for normal operation at 32 MHz CPU clock and around 4.2 uA for normal operation when working at 32.768 kHz CPU clock. A free evaluation version of CubeSuite+ for programming RL78/G13 is available online and it can be downloaded from the address:
http://am.renesas.com/products/tools/ide/ide_cubesuite_plus/downloads.jsp#.

DISPLAY

The display on EVAL-ADXL362Z-DB is the electronic paper display from Eink. It only consume power when the image changes and it can retain an image when disconnected from a driving source without consuming any additional energy. The drive current is based on the figure of 0.5uA per square centimeter.

DISPLAY DRIVER

The display driver is DA8521. It features very low standby current which is smaller than 1uA. After writing data to the display, the device can be completely switched off and the data will remain displayed.

NOTES

**ESD Caution**

ESD (electrostatic discharge) sensitive device. Charged devices and circuit boards can discharge without detection. Although this product features patented or proprietary protection circuitry, damage may occur on devices subjected to high energy ESD. Therefore, proper ESD precautions should be taken to avoid performance degradation or loss of functionality.

Legal Terms and Conditions

By using the evaluation board discussed herein (together with any tools, components documentation or support materials, the "Evaluation Board"), you are agreeing to be bound by the terms and conditions set forth below ("Agreement") unless you have purchased the Evaluation Board, in which case the Analog Devices Standard Terms and Conditions of Sale shall govern. Do not use the Evaluation Board until you have read and agreed to the Agreement. Your use of the Evaluation Board shall signify your acceptance of the Agreement. This Agreement is made by and between you ("Customer") and Analog Devices, Inc. ("ADI"), with its principal place of business at One Technology Way, Norwood, MA 02062, USA. Subject to the terms and conditions of the Agreement, ADI hereby grants to Customer a free, limited, personal, temporary, non-exclusive, non-sublicensable, non-transferable license to use the Evaluation Board FOR EVALUATION PURPOSES ONLY. Customer understands and agrees that the Evaluation Board is provided for the sole and exclusive purpose referenced above, and agrees not to use the Evaluation Board for any other purpose. Furthermore, the license granted is expressly made subject to the following additional limitations: Customer shall not (i) rent, lease, display, sell, transfer, assign, sublicense, or distribute the Evaluation Board; and (ii) permit any Third Party to access the Evaluation Board. As used herein, the term "Third Party" includes any entity other than ADI, Customer, their employees, affiliates and in-house consultants. The Evaluation Board is NOT sold to Customer; all rights not expressly granted herein, including ownership of the Evaluation Board, are reserved by ADI. CONFIDENTIALITY. This Agreement and the Evaluation Board shall all be considered the confidential and proprietary information of ADI. Customer may not disclose or transfer any portion of the Evaluation Board to any other party for any reason. Upon discontinuation of use of the Evaluation Board or termination of this Agreement, Customer agrees to promptly return the Evaluation Board to ADI. ADDITIONAL RESTRICTIONS. Customer may not disassemble, decompile or reverse engineer chips on the Evaluation Board. Customer shall inform ADI of any occurred damages or any modifications or alterations it makes to the Evaluation Board, including but not limited to soldering or any other activity that affects the material content of the Evaluation Board. Modifications to the Evaluation Board must comply with applicable law, including but not limited to the RoHS Directive. TERMINATION. ADI may terminate this Agreement at any time upon giving written notice to Customer. Customer agrees to return to ADI the Evaluation Board at that time. LIMITATION OF LIABILITY. THE EVALUATION BOARD PROVIDED HEREUNDER IS PROVIDED "AS IS" AND ADI MAKES NO WARRANTIES OR REPRESENTATIONS OF ANY KIND WITH RESPECT TO IT. ADI SPECIFICALLY DISCLAIMS ANY REPRESENTATIONS, ENDORSEMENTS, GUARANTEES, OR WARRANTIES, EXPRESS OR IMPLIED, RELATED TO THE EVALUATION BOARD INCLUDING, BUT NOT LIMITED TO, THE IMPLIED WARRANTY OF MERCHANTABILITY, TITLE, FITNESS FOR A PARTICULAR PURPOSE OR NON-INFRINGEMENT OF INTELLECTUAL PROPERTY RIGHTS. IN NO EVENT WILL ADI AND ITS LICENSORS BE LIABLE FOR ANY INCIDENTAL, SPECIAL, INDIRECT, OR CONSEQUENTIAL DAMAGES RESULTING FROM CUSTOMER'S POSSESSION OR USE OF THE EVALUATION BOARD, INCLUDING BUT NOT LIMITED TO LOST PROFITS, DELAY COSTS, LABOR COSTS OR LOSS OF GOODWILL. ADI'S TOTAL LIABILITY FROM ANY AND ALL CAUSES SHALL BE LIMITED TO THE AMOUNT OF ONE HUNDRED US DOLLARS (\$100.00). EXPORT. Customer agrees that it will not directly or indirectly export the Evaluation Board to another country, and that it will comply with all applicable United States federal laws and regulations relating to exports. GOVERNING LAW. This Agreement shall be governed by and construed in accordance with the substantive laws of the Commonwealth of Massachusetts (excluding conflict of law rules). Any legal action regarding this Agreement will be heard in the state or federal courts having jurisdiction in Suffolk County, Massachusetts, and Customer hereby submits to the personal jurisdiction and venue of such courts. The United Nations Convention on Contracts for the International Sale of Goods shall not apply to this Agreement and is expressly disclaimed.

©2010–2011 Analog Devices, Inc. All rights reserved. Trademarks and registered trademarks are the property of their respective owners.

UUG08658-0-3/11(A)



www.analog.com