



45 dB Gain, 23 dBm IP3, 2.5 dB NF, 11 dBm P1dB,
0.01 MHz to 500 MHz, Low Noise Amplifier, SMA

TECHNICAL DATA SHEET

PE15A1046

The PE15A1046 is a low noise coaxial amplifier operating in the 10 KHz to 500 MHz frequency range. Impressive broadband typical performance includes 2.5 dB noise figure, 45 dB small signal gain, +13 dBm P1dB, and an output 3rd order intercept point of +23 dBm. This exceptional technical performance is achieved through the use of a hybrid MIC design and advanced Bipolar devices. The low noise amplifier requires a +15V DC power supply, and operates over a temperature range of -40°C to +75°C. The rugged and compact package supports SMA Female connectors and RFI and Ground pins. And for highly reliable operation, the model is guaranteed to meet MIL-STD-202 environmental test conditions for Humidity, Shock, Vibration, and Altitude.

Features

- 10 KHz to 500 MHz Frequency Range
- Low Noise Figure: 2.5 dB
- High Dynamic Range
- Efficient GaAs pHEMT Design
- Small Signal Gain: 45 dB
- Output P1dB: +13 dBm
- Output IP3: +23 dBm
- Operating Temperature: -40°C to +75°C
- 50 Ohm Input and Output Matched
- DC Power Supply: +15V / 75 mA
- SMA Female Connectors
- Designed to meet MIL-STD-202 Test Conditions

Applications

- Test & Measurement
- R&D Labs
- General Purpose Amplification
- Aerospace & Defense
- Wireless Infrastructure
- Communication Systems

Electrical Specifications (TA = +25°C, DC Voltage = 15Vdc, DC Current = 75mA)

Description	Minimum	Typical	Maximum	Units
Frequency Range	10KHz		500	MHz
Small Signal Gain	44	45		dB
Gain Flatness			±0.5	dB
Output at 1 dB Compression Point	+13	+11		dBm
Output 3rd Intercept Point	+20	+23		dBm
Noise Figure		2.5	3	dB
Input VSWR		1.4:1	2:1	
Output VSWR		1.3:1	2:1	
Reverse Isolation		-55		dB
Operating DC Voltage	14	15	16	Volts
Operating DC Current		75	90	mA
Operating Temperature Range	-40		+75	°C

Click the following link (or enter part number in "SEARCH" on website) to obtain additional part information including price, inventory and certifications: [45 dB Gain, 23 dBm IP3, 2.5 dB NF, 11 dBm P1dB, 0.01 MHz to 500 MHz, Low Noise Amplifier, SMA PE15A1046](#)



45 dB Gain, 23 dBm IP3, 2.5 dB NF, 11 dBm P1dB,
0.01 MHz to 500 MHz, Low Noise Amplifier, SMA

TECHNICAL DATA SHEET

PE15A1046

Absolute Maximum Rating

Parameter	Rating	Units
Supply Voltage	+18	V
RF Input Power	+13	dBm
Operating Temperature	-40 to +85	°C
Storage Temperature	-55 to +125	°C



ESD Sensitive Material,
Transport material in
Approved ESD bags.
Handle only in approved
ESD Workstation.

Mechanical Specifications

Size

Input Connector SMA Female
Output Connector SMA Female

Environmental Specifications

Temperature

Operating Range -40 to +75 deg C
Storage Range -55 to +125 deg C

Humidity MIL-STD-202F, Method 103B, Condition B
Shock MIL-STD-202F, Method 213B, Condition B
Vibration MIL-STD-202F, Method 204D, Condition B
Altitude MIL-STD-202F, Method 105C, Condition B

Compliance Certifications (see [product page](#) for current document)

Plotted and Other Data

Notes:

- Values at +25 °C, sea level
- ESD Sensitive Material, Transport material in Approved ESD bags. Handle only in approved ESD Workstation.

Click the following link (or enter part number in "SEARCH" on website) to obtain additional part information including price, inventory and certifications: [45 dB Gain, 23 dBm IP3, 2.5 dB NF, 11 dBm P1dB, 0.01 MHz to 500 MHz, Low Noise Amplifier, SMA PE15A1046](#)



45 dB Gain, 23 dBm IP3, 2.5 dB NF, 11 dBm P1dB,
0.01 MHz to 500 MHz, Low Noise Amplifier, SMA

TECHNICAL DATA SHEET

PE15A1046

Typical Performance Data

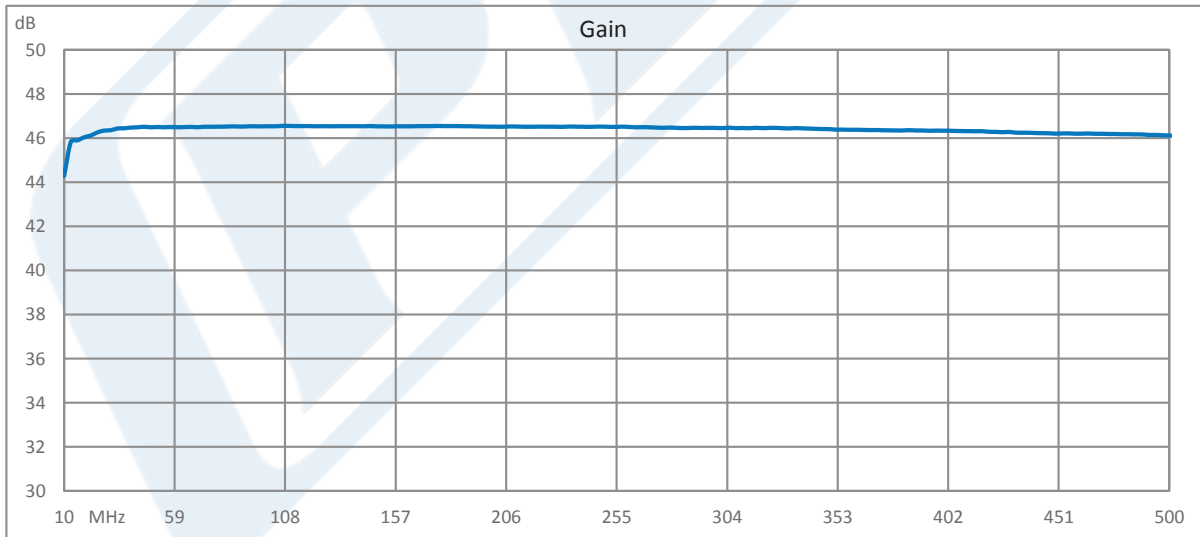
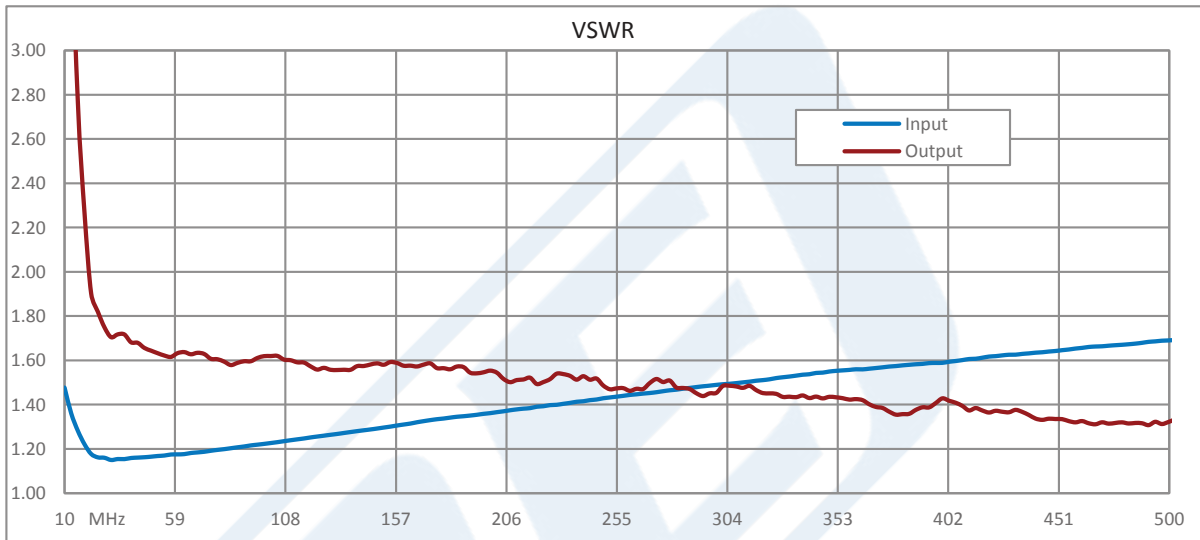

Click the following link (or enter part number in "SEARCH" on website) to obtain additional part information including price, inventory and certifications: [45 dB Gain, 23 dBm IP3, 2.5 dB NF, 11 dBm P1dB, 0.01 MHz to 500 MHz, Low Noise Amplifier, SMA PE15A1046](#)



45 dB Gain, 23 dBm IP3, 2.5 dB NF, 11 dBm P1dB,
0.01 MHz to 500 MHz, Low Noise Amplifier, SMA

TECHNICAL DATA SHEET

PE15A1046

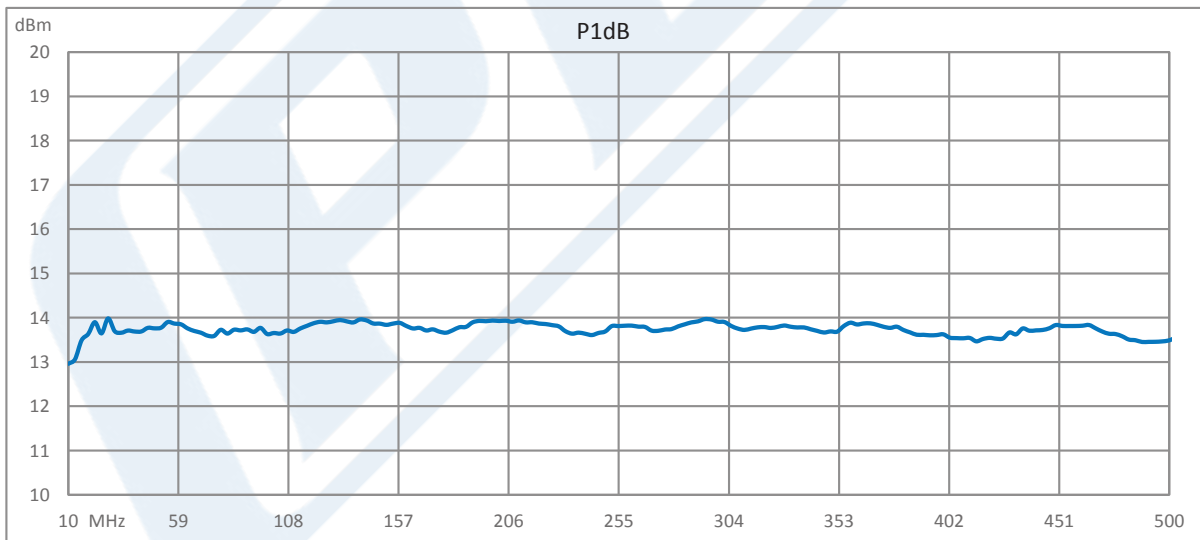
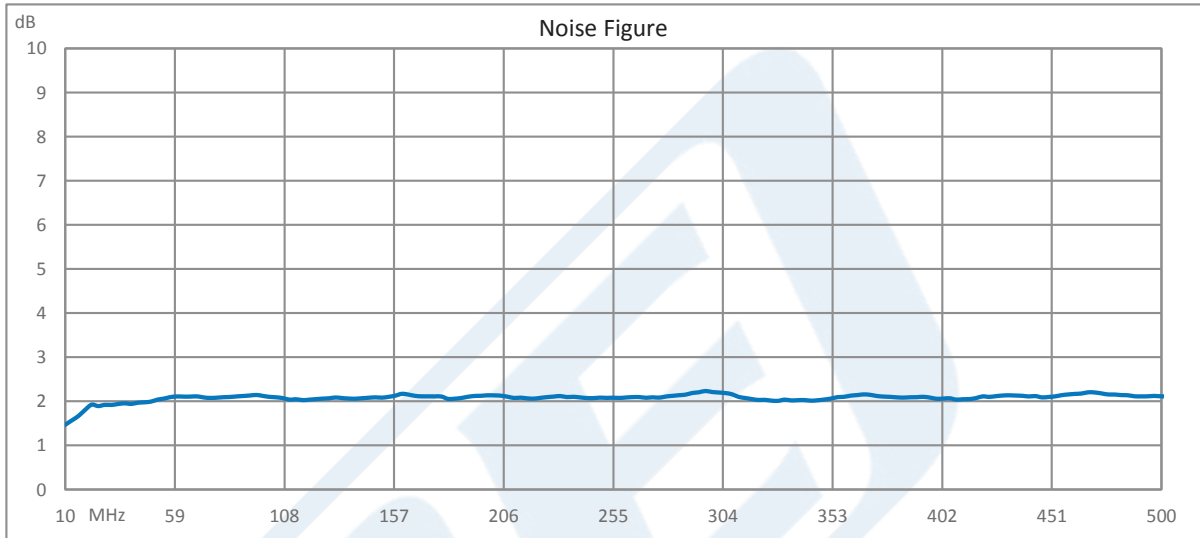

Click the following link (or enter part number in "SEARCH" on website) to obtain additional part information including price, inventory and certifications: [45 dB Gain, 23 dBm IP3, 2.5 dB NF, 11 dBm P1dB, 0.01 MHz to 500 MHz, Low Noise Amplifier, SMA PE15A1046](#)



45 dB Gain, 23 dBm IP3, 2.5 dB NF, 11 dBm P1dB,
0.01 MHz to 500 MHz, Low Noise Amplifier, SMA

TECHNICAL DATA SHEET

PE15A1046

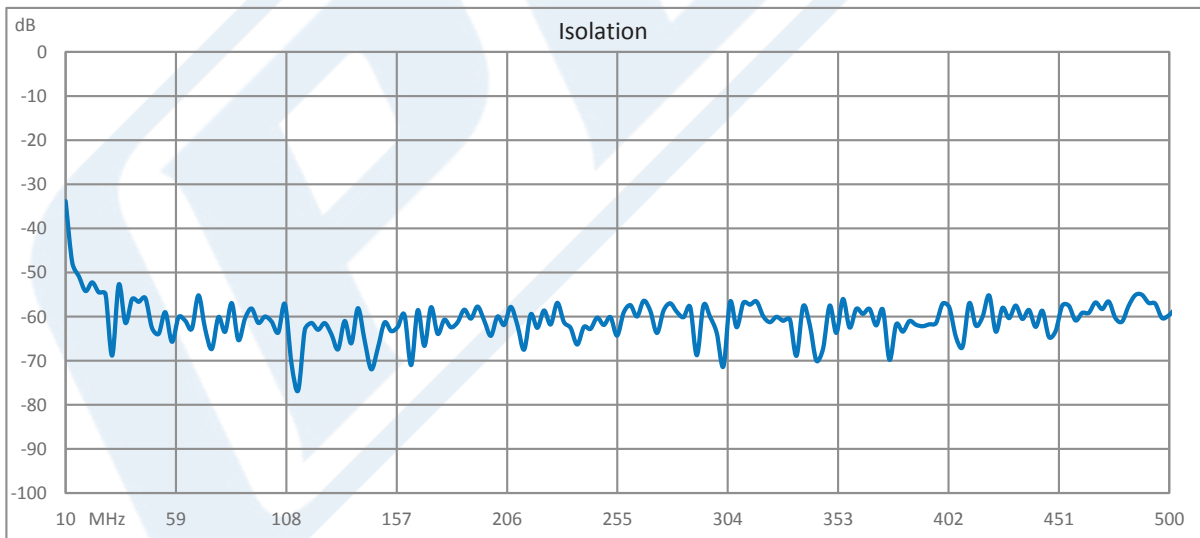
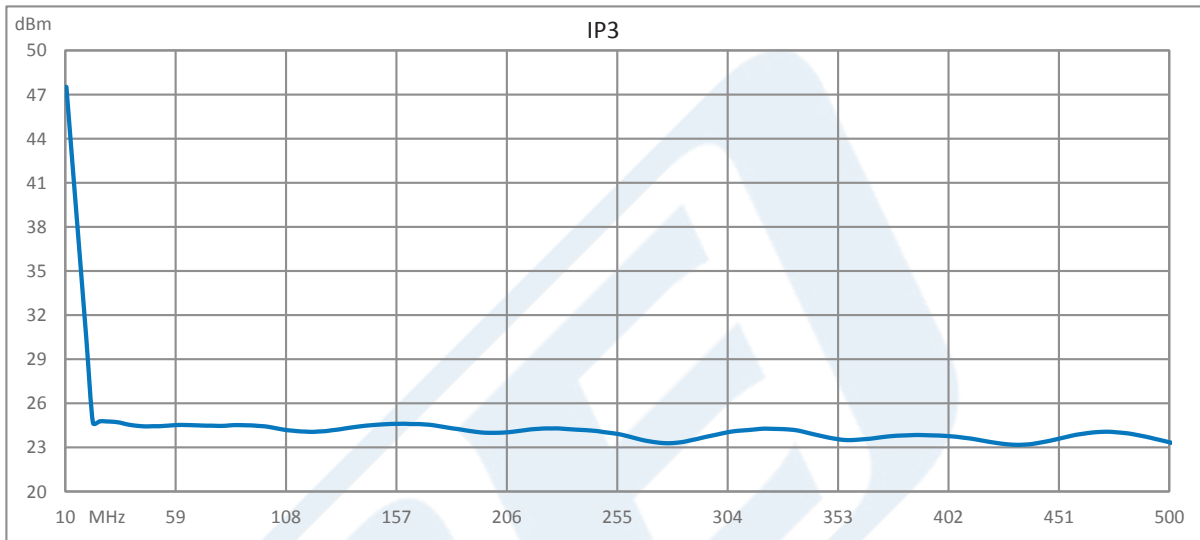

Click the following link (or enter part number in "SEARCH" on website) to obtain additional part information including price, inventory and certifications: [45 dB Gain, 23 dBm IP3, 2.5 dB NF, 11 dBm P1dB, 0.01 MHz to 500 MHz, Low Noise Amplifier, SMA PE15A1046](#)



45 dB Gain, 23 dBm IP3, 2.5 dB NF, 11 dBm P1dB,
0.01 MHz to 500 MHz, Low Noise Amplifier, SMA

TECHNICAL DATA SHEET

PE15A1046

45 dB Gain, 23 dBm IP3, 2.5 dB NF, 11 dBm P1dB, 0.01 MHz to 500 MHz, Low Noise Amplifier, SMA from Pasternack Enterprises has same day shipment for domestic and International orders. Our RF, microwave and millimeter wave products maintain a 99.4% availability and are part of the broadest selection in the industry.

Click the following link (or enter part number in "SEARCH" on website) to obtain additional part information including price, inventory and certifications: [45 dB Gain, 23 dBm IP3, 2.5 dB NF, 11 dBm P1dB, 0.01 MHz to 500 MHz, Low Noise Amplifier, SMA PE15A1046](https://www.pasternack.com/45-db-gain-23-dbm-ip3-2.5-db-nf-11-dbm-p1db-0.01-mhz-to-500-mhz-low-noise-amplifier-sma-pe15a1046)

URL: <https://www.pasternack.com/45-db-gain-2.5-db-500-mhz-low-noise-amplifier-sma-pe15a1046-p.aspx>

The information contained in this document is accurate to the best of our knowledge and representative of the part described herein. It may be necessary to make modifications to the part and/or the documentation of the part, in order to implement improvements. Pasternack reserves the right to make such changes as required. Unless otherwise stated, all specifications are nominal. Pasternack does not make any representation or warranty regarding the suitability of the part described herein for any particular purpose, and Pasternack does not assume any liability arising out of the use of any part or documentation.

PE15A1046 CAD Drawing

45 dB Gain, 23 dBm IP3, 2.5 dB NF, 11 dBm P1dB, 0.01 MHz to 500 MHz, Low Noise Amplifier, SMA

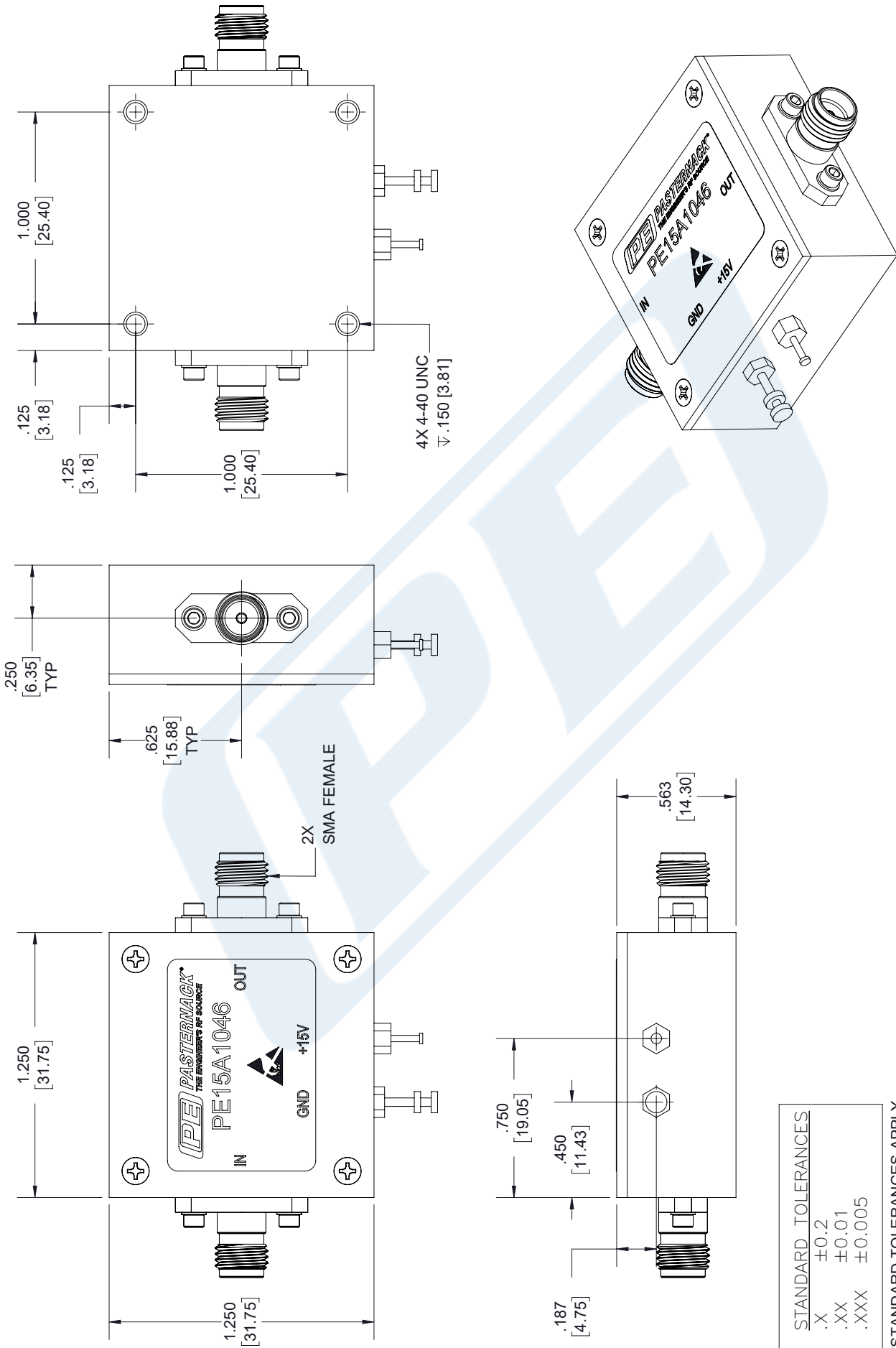

STANDARD TOLERANCES	
.X	±0.2
.XX	±0.01
.XXX	±0.005

*STANDARD TOLERANCES APPLY ONLY TO DIMENSIONS IN INCHES



Pasternack Enterprises, Inc.
 P.O. Box 16759 | Irvine | CA | 92623
 Phone: (949) 261-1920 | Fax: (949) 261-7451
 Website: www.pasternack.com | E-Mail: sales@pasternack.com

DWG TITLE

PE15A1046

CAGE CODE 53919

NOTES:
 1. UNLESS OTHERWISE SPECIFIED ALL DIMENSIONS ARE NOMINAL.
 2. ALL SPECIFICATIONS ARE SUBJECT TO CHANGE WITHOUT NOTICE AT ANY TIME.
 3. DIMENSIONS ARE IN INCHES [mm].

CAD FILE 04/23/18

SCALE N/A

SIZE A

7361