

6 5 4 3 2 1

D

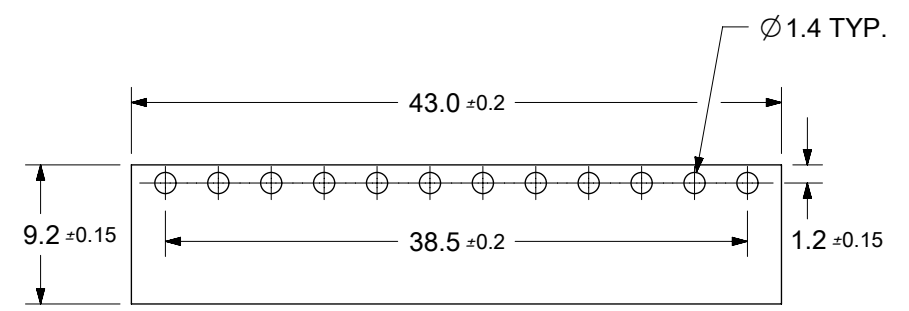

C

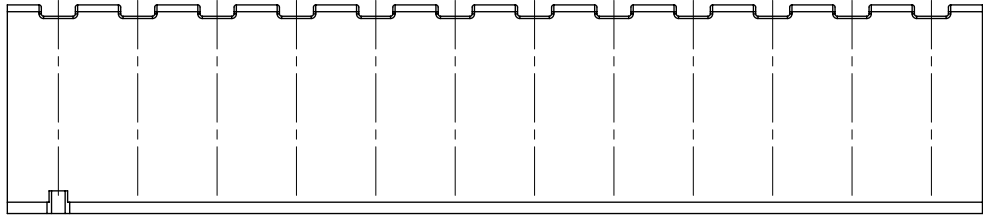

B

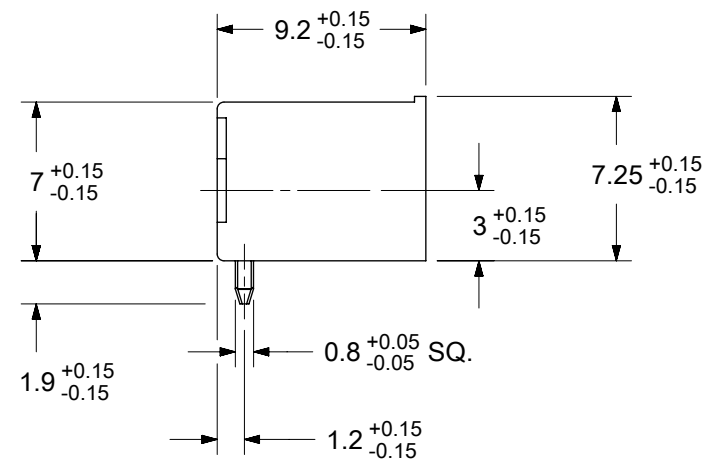
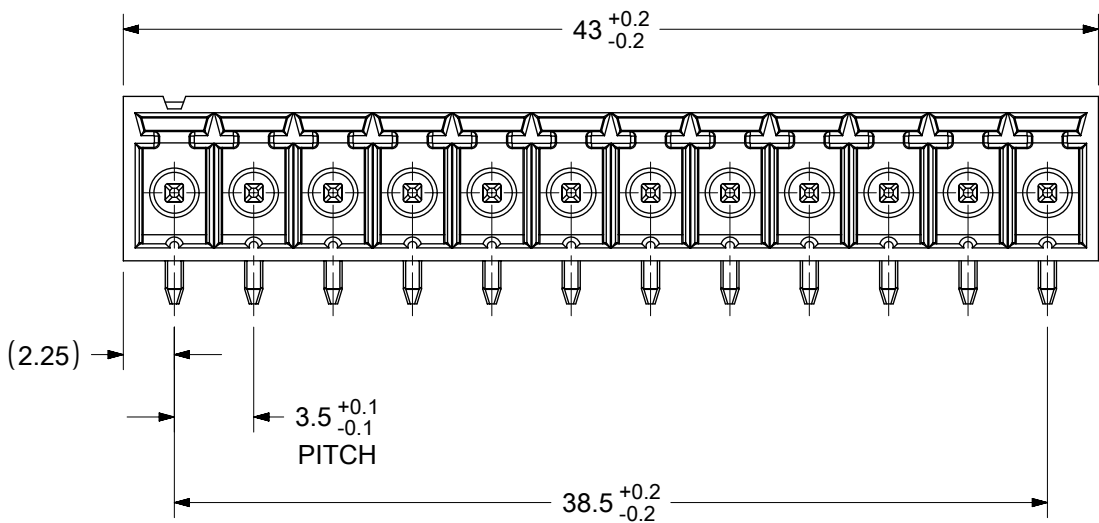

A

SPECIFICATIONS

MATERIAL:

- 1. HOUSING: PA46 GF UL94V-0; COLOR: GREEN
- 2. TERMINAL: TIN PLATED COPPER ALLOY

ELECTRICAL RATINGS:

- 1. MAXIMUM VOLTAGE: 300V (PER UL)
- 2. MAXIMUM CURRENT: 11A (PER UL)

FUNCTIONAL SYMBOLS $\frac{E}{A} = 0$ $\frac{E}{E} = 0$ $\frac{E}{P} = 0$ DIVISIONAL SYMBOLS	THIS DRAWING CONTAINS INFORMATION THAT IS PROPRIETARY TO MOLEX ELECTRONIC TECHNOLOGIES, LLC AND SHOULD NOT BE USED WITHOUT WRITTEN PERMISSION		CURRENT REV DESC: INITIAL RELEASE						
	DIMENSION UNITS	SCALE	GENERAL TOLERANCES (UNLESS SPECIFIED)					EC NO: 645226	
	mm	3:1	ANGULAR TOL ± °		DRWN: ABENJAMINLW 2020/07/13				
	4 PLACES	± ---	4 PLACES ± ---		CHK'D: DACHAMMER 2020/09/10				
3 PLACES	± ---	2 PLACES ± ---		APPR: JFMURPHY 2020/10/19		PRODUCT CUSTOMER DRAWING			
2 PLACES	± ---	1 PLACE ± ---		INITIAL REVISION:		DOCUMENT NUMBER	DOC TYPE	DOC PART	REVISION
1 PLACE	± ---	0 PLACES ± ---		DRWN: ABENJAMINLW 2020/07/13		395023012	PSD	000	A
0 PLACES	± ---	DRAFT WHERE APPLICABLE MUST REMAIN WITHIN DIMENSIONS		THIRD ANGLE PROJECTION	DRAWING	SERIES	MATERIAL NUMBER	CUSTOMER	SHEET NUMBER
					A-SIZE	39502	395023012		1 OF 2

DOCUMENT STATUS	P1	RELEASE DATE	2020/10/19	17:06:27
-----------------	----	--------------	------------	----------

6 5 4 3 2 1

FORMAT: master-db-prod-A
REVISION: J
DATE: 2020/01/14

PRODUCT LABEL

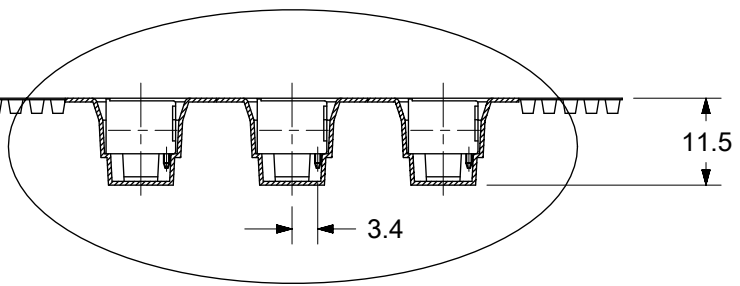
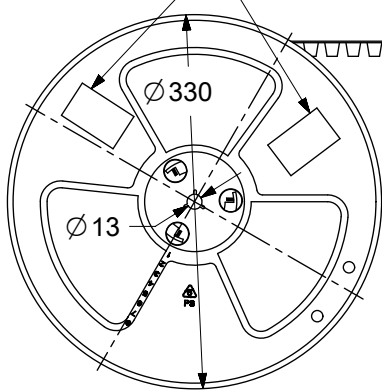

SPROCKET HOLES

PICK & PLACE AREA

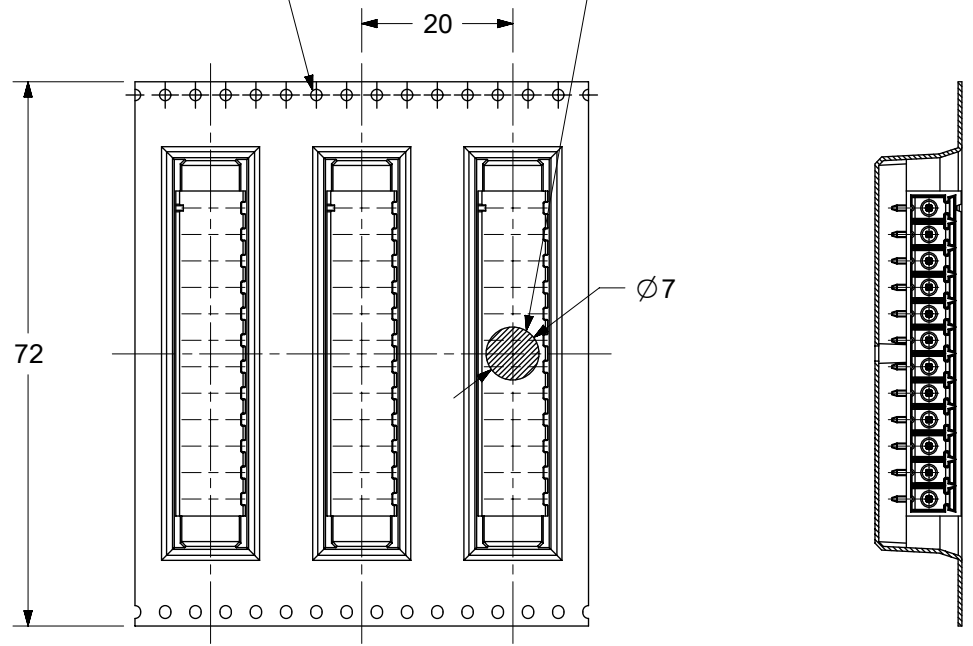

TAPE & REEL PACKAGING DETAILS

FUNCTIONAL SYMBOLS $\frac{E}{A} = 0$ $\frac{E}{C} = 0$ $\frac{E}{P} = 0$	DIMENSION UNITS mm	SCALE 1:1	THIS DRAWING CONTAINS INFORMATION THAT IS PROPRIETARY TO MOLEX ELECTRONIC TECHNOLOGIES, LLC AND SHOULD NOT BE USED WITHOUT WRITTEN PERMISSION CURRENT REV DESC: INITIAL RELEASE			
	GENERAL TOLERANCES (UNLESS SPECIFIED)		EC NO: 645226 DRWN: ABENJAMINLW 2020/07/13 CHK'D: DACHAMMER 2020/09/10 APPR: JFMURPHY 2020/10/19			
	ANGULAR TOL ± °		INITIAL REVISION: DRWN: ABENJAMINLW 2020/07/13 APPR: JFMURPHY 2020/10/19			
	DIVISIONAL SYMBOLS 4 PLACES ± --- 3 PLACES ± --- 2 PLACES ± --- 1 PLACE ± --- 0 PLACES ± ---		DRAFT WHERE APPLICABLE MUST REMAIN WITHIN DIMENSIONS			
PRODUCT CUSTOMER DRAWING			DOCUMENT NUMBER 395023012	DOC TYPE PSD	DOC PART 000	REVISION A
DRAFT WHERE APPLICABLE MUST REMAIN WITHIN DIMENSIONS		THIRD ANGLE PROJECTION	DRAWING A-SIZE	SERIES 39502	MATERIAL NUMBER 395023012	CUSTOMER SHEET NUMBER 2 OF 2



3.50MM PITCH HEADER, 12 POLES
 HORIZONTAL, HIGH TEMP HOUSING,
 TAPE & REEL PACKAGING

FORMAT: master-ib-prod-A
 REVISION: J
 DATE: 2020/01/14