

### 8 PIN SOP DUAL CHANNEL HIGH SPEED 10MBit/s LOGIC GATE PHOTOCOUPLER EL063X Series

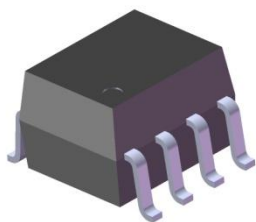

Schematic

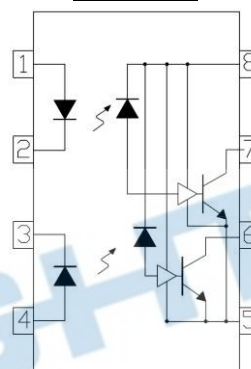

Pin Configuration

- 1. Anode
- 2. Cathode
- 3. Cathode
- 4. Anode
- 5. Gnd
- 6. Vout 2
- 7. Vout 1
- 8. VCC

#### Features

- Compliance Halogen Free .  
(Br <900 ppm ,Cl <900 ppm , Br+Cl < 1500 ppm)
- High speed 10Mbit/s
- 10kV/μs min. common mode transient immunity (EL0631)
- Guaranteed performance from -40 to 85°C
- Wide operating temperature range of -40°C to 100°C
- Logic gate output
- High isolation voltage between input and output (Viso=3750 V rms )
- Compliance with EU REACH
- Pb free and RoHS compliant
- UL and cUL approved(No. E214129)
- VDE approved (No.40028116)
- SEMKO approved
- NEMKO approved
- DEMKO approved
- FIMKO approved

#### Description

The EL0630 and EL0631 are dual channel devices each consists of an infrared emitting diode optically coupled to a high speed integrated photo detector logic gate with a strobable output.

The devices are packaged in an 8-pin small outline package which conforms to the standard SO8 footprint.

#### Applications

- Ground loop elimination
- LSTTL to TTL, LSTTL or 5 volt CMOS
- Line receiver, data transmission
- Data multiplexing
- Switching power supplies
- Pulse transformer replacement
- Computer peripheral interface

#### Truth Table (Positive Logic)

Input	Output
H	L
L	H

**Absolute Maximum Ratings (Ta=25°C)**

	Parameter	Symbol	Rating	Unit
Input	DC/ Average Forward current	$I_F$	20	mA
	Reverse voltage	$V_R$	5	V
	Power dissipation	$P_D$	45	mW
Output	Power dissipation	$P_C$	60	mW
	Output current	$I_O$	50	mA
	Output voltage	$V_O$	7.0	V
	Supply voltage (max 1 minute)	$V_{CC}$	7.0	V
	Output Power Dissipation	$P_O$	80	mW
	Isolation voltage <sup>*1</sup>	$V_{ISO}$	3750	V rms
	Operating temperature	$T_{OPR}$	-40 ~ +100	°C
	Storage temperature	$T_{STG}$	-55 ~ +125	°C
	Soldering temperature <sup>*2</sup>	$T_{SOL}$	260	°C

Notes:

\*1 AC for 1 minute, R.H.= 40 ~ 60% R.H. In this test, pins 1, 2, 3, 4 are shorted together, and pins 5, 6, 7, 8 are shorted together.

\*2 For 10 seconds

**Electrical Characteristics (Ta=-40 to 85°C unless specified otherwise)**

**Input**

Parameter	Symbol	Min.	Typ.	Max.	Unit	Condition
Forward voltage	$V_F$	-	1.4	1.8	V	$I_F=10\text{mA}$
Reverse voltage	$V_R$	5.0	-	-	V	$I_R=10\mu\text{A}$
Temperature coefficient of forward voltage	$\Delta V_F/\Delta T_A$	-	-1.8	-	mV/°C	$I_F=10\text{mA}$
Input capacitance	$C_{IN}$	-	60	-	pF	$V_F=0, f=1\text{MHz}$

**Output**

Parameter	Symbol	Min	Typ.	Max.	Unit	Condition
High level supply current	$I_{CCH}$	-	13	18	mA	$I_F=0\text{mA}, V_{CC}=5.5\text{V}$
Low level supply current	$I_{CCL}$	-	15	21	mA	$I_F=10\text{mA}, V_{CC}=5.5\text{V}$

**Transfer Characteristics (Ta=-40 to 85°C unless specified otherwise)**

Parameter	Symbol	Min	Typ.	Max.	Unit	Condition
HIGH Level Output Current	$I_{OH}$	-	-	100	$\mu\text{A}$	$V_{CC}=5.5\text{V}, V_O=5.5\text{V}, I_F=250\mu\text{A},$
LOW Level Output Current	$V_{OL}$	-	-	0.6	V	$V_{CC}=5.5\text{V}, I_F=5\text{mA}, I_{CL}=13\text{mA}$
Input Threshold Current	$I_{FT}$	-	-	5	mA	$V_{CC}=5.5\text{V}, V_O=0.6\text{V}, I_{OL}=13\text{mA}$

Switching Characteristics (T<sub>a</sub>=-40 to 85°C, V<sub>CC</sub>=5V, I<sub>F</sub>=7.5mA unless specified otherwise)

Parameter	Symbol	Min	Typ.	Max.	Unit	Condition
Propagation delay time to output High level* <sup>4</sup> (Fig.11)	t <sub>PHL</sub>	-	-	100	ns	C <sub>L</sub> =15pF, R <sub>L</sub> =350Ω, T <sub>A</sub> =25°C
Propagation delay time to output Low level* <sup>5</sup> (Fig.11)	t <sub>PLH</sub>	-	-	100	ns	C <sub>L</sub> =15pF, R <sub>L</sub> =350Ω, T <sub>A</sub> =25°C
Pulse width distortion	t <sub>PHL</sub> - t <sub>PLH</sub>	-	-	35	ns	C <sub>L</sub> =15pF, R <sub>L</sub> =350Ω
Output rise time* <sup>6</sup> (Fig.11)	t <sub>r</sub>	-	40	-	ns	C <sub>L</sub> =15pF, R <sub>L</sub> =350Ω
Output fall time* <sup>7</sup> (Fig.11)	t <sub>f</sub>	-	10	-	ns	C <sub>L</sub> =15pF, R <sub>L</sub> =350Ω
Common Mode Transient Immunity at Logic High* <sup>8</sup>	EL0630 ICM <sub>HI</sub>	5000	-	-	V/μs	I <sub>F</sub> =0mA, V <sub>OH(MIN)</sub> =2.0V, R <sub>L</sub> =350Ω, T <sub>A</sub> =25°C  V <sub>CM</sub>  =1KV(Fig.12)
	EL0631	10000	-	-	V/μs	I <sub>F</sub> =0mA, V <sub>OH(MIN)</sub> =2.0V, R <sub>L</sub> =350Ω, T <sub>A</sub> =25°C  V <sub>CM</sub>  =1KV(Fig.12)
Common Mode Transient Immunity at Logic Low* <sup>9</sup>	EL0630 ICM <sub>LI</sub>	5000	-	-	V/μs	I <sub>F</sub> =7.5mA, V <sub>OL(MAX)</sub> =0.8V, R <sub>L</sub> =350Ω, T <sub>A</sub> =25°C  V <sub>CM</sub>  =1KV(Fig.12)
	EL0631	10000	-	-	V/μs	I <sub>F</sub> =7.5mA, V <sub>OL(MAX)</sub> =0.8V, R <sub>L</sub> =350Ω, T <sub>A</sub> =25°C  V <sub>CM</sub>  =1KV(Fig.12)

Typical Electro-Optical Characteristics Curves

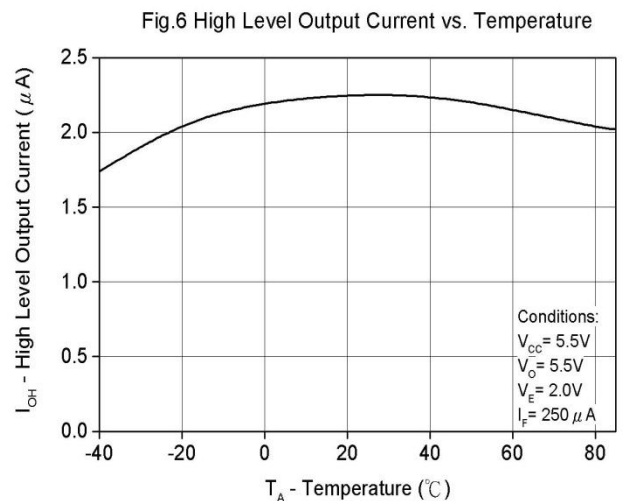
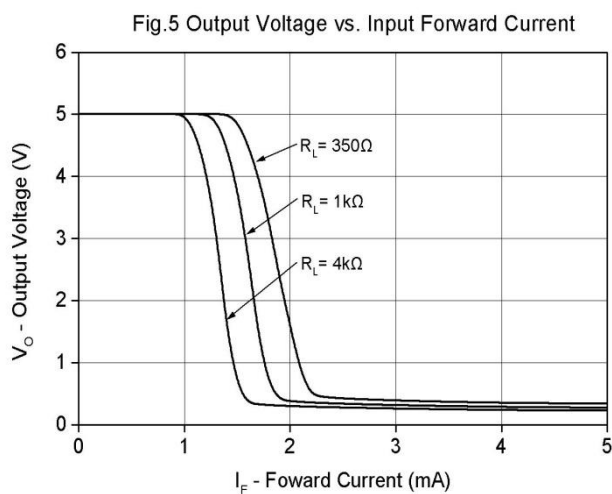
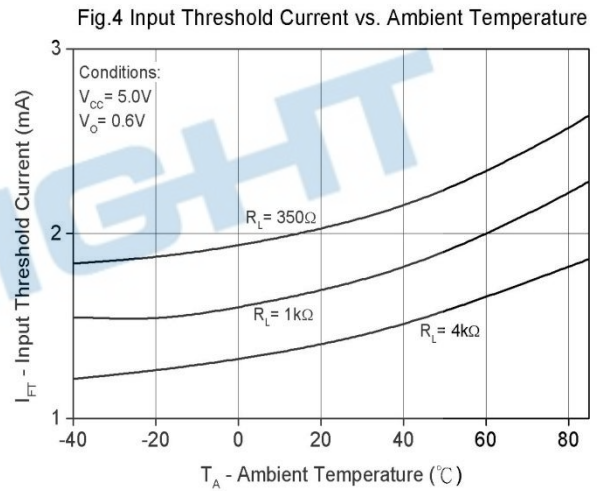
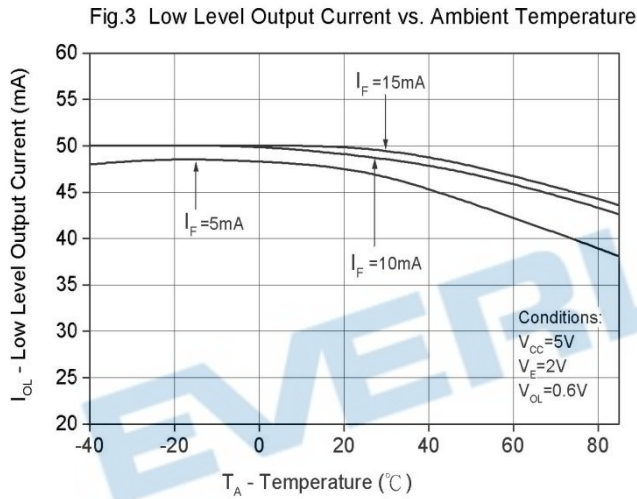
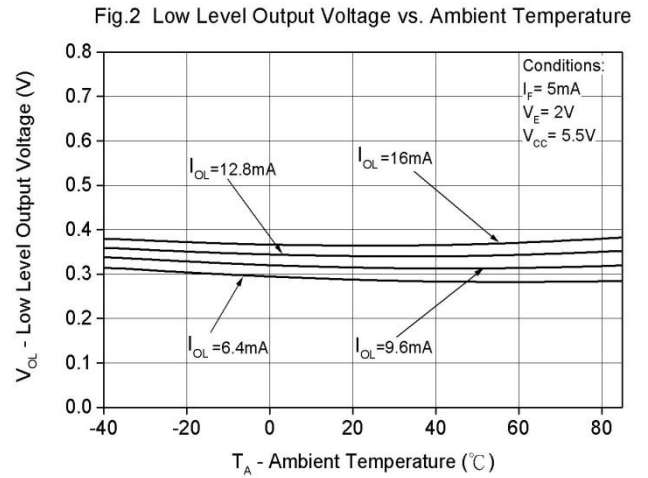
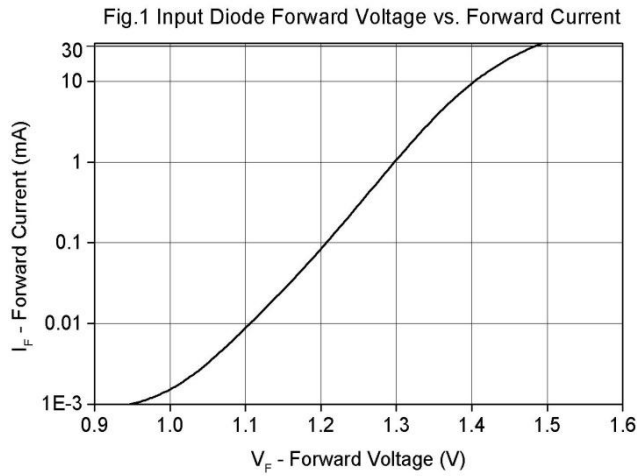

Fig.7 Switching Time vs. Forward Current

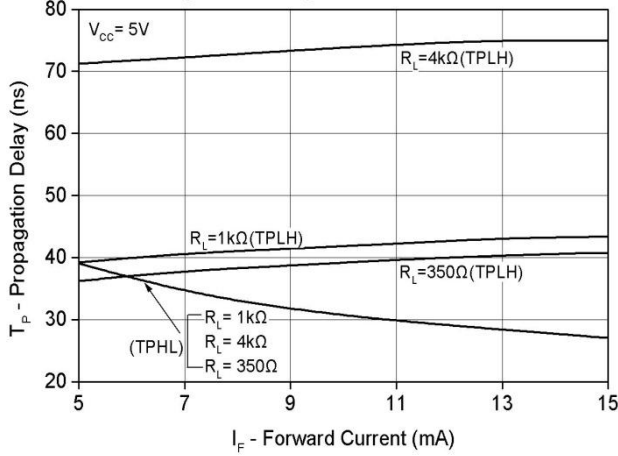

Fig.8 Switching Time vs. Temperature

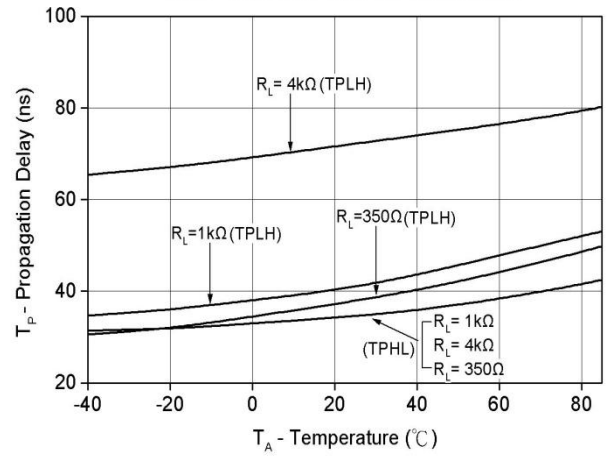

Fig.9 Pulse Width Distortion vs. Temperature

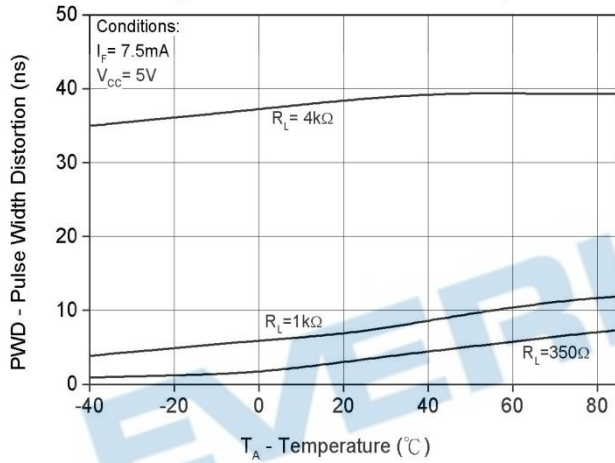

Fig.10 Rise and Fall Time vs. Temperature

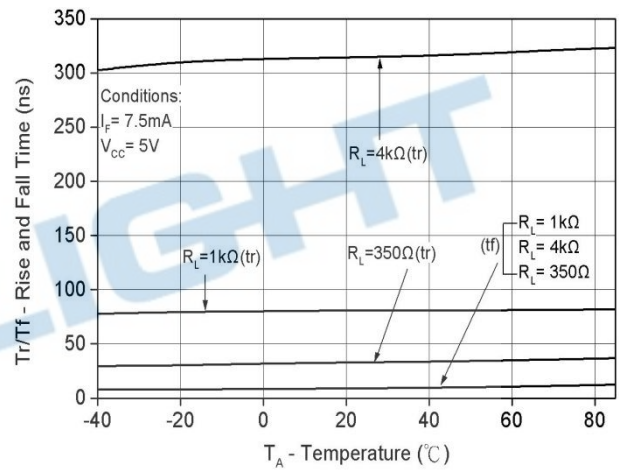



Fig. 11 Test circuit and waveforms for  $t_{PHL}$ ,  $t_{PLH}$ ,  $t_r$ , and  $t_f$

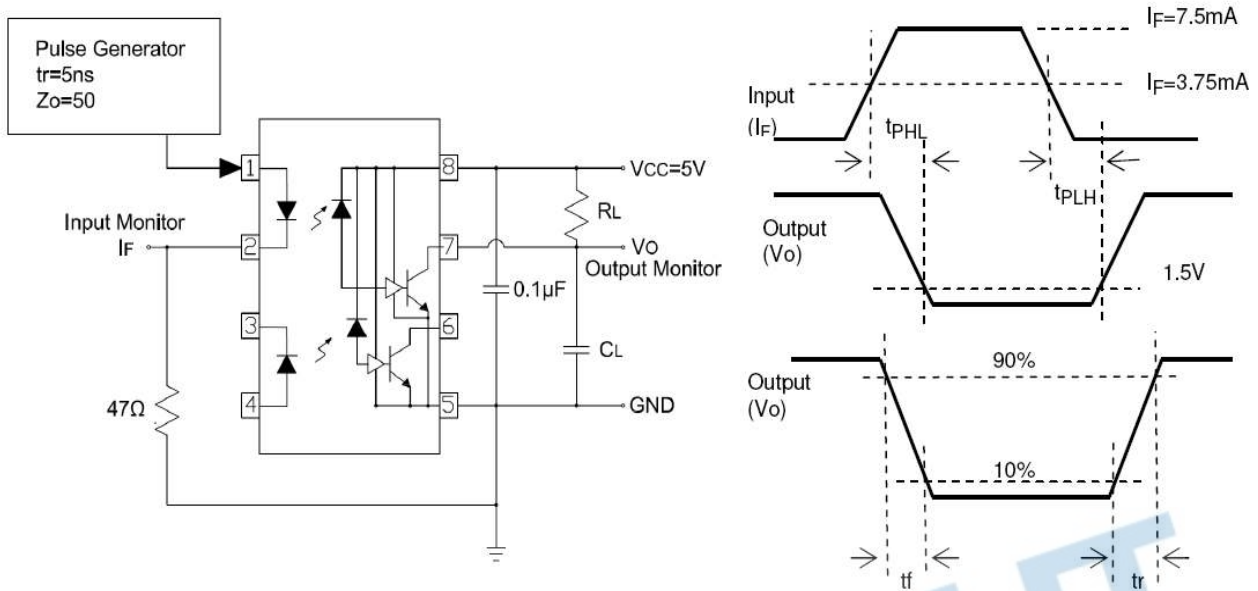
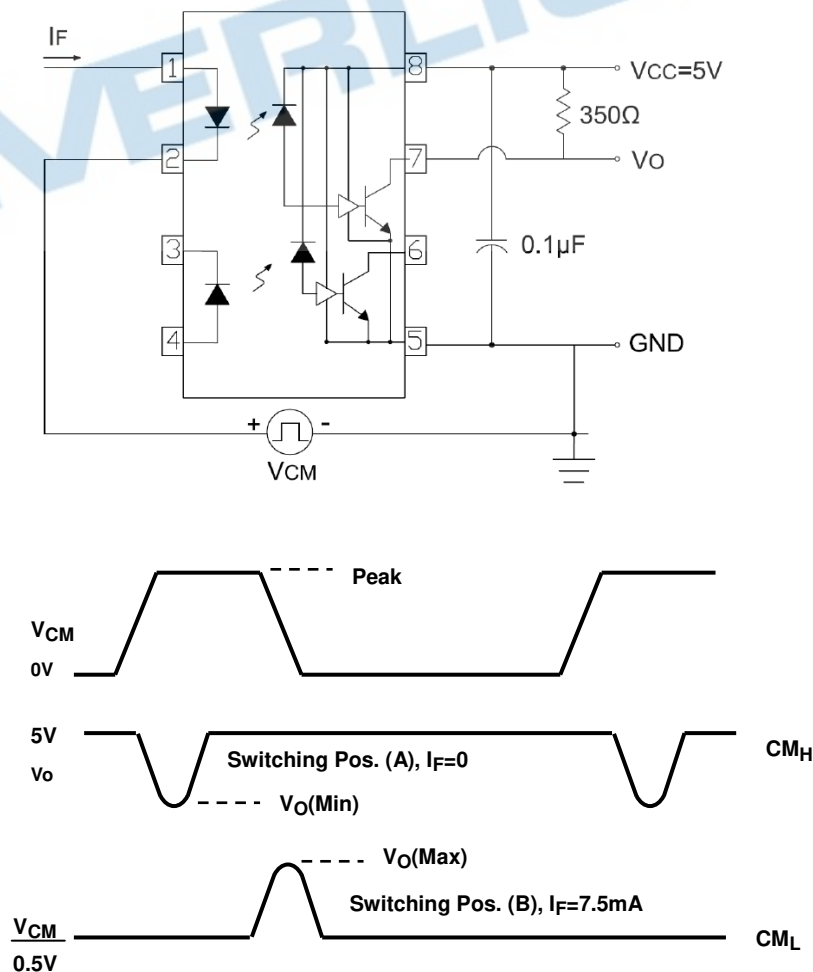

Fig. 12 Test circuit Common mode Transient Immunity



**Notes**

- \*3 The  $V_{CC}$  supply must be bypassed by a 0.1 $\mu$ F capacitor or larger. This can be either a ceramic or solid tantalum capacitor with good high frequency characteristic and should be connected as close as possible to the package  $V_{CC}$  and GND pins
- \*4.  $t_{PLH}$  – Propagation delay is measured from the 3.75mA level on the HIGH to LOW transition of the input current pulse to the 1.5 V level on the LOW to HIGH transition of the output voltage pulse.
- \*5.  $t_{PHL}$  – Propagation delay is measured from the 3.75mA level on the LOW to HIGH transition of the input current pulse to the 1.5 V level on the HIGH to LOW transition of the output voltage pulse.
- \*6.  $t_r$  – Rise time is measured from the 90% to the 10% levels on the LOW to HIGH transition of the output pulse.
- \*7.  $t_f$  – Fall time is measured from the 10% to the 90% levels on the HIGH to LOW transition of the output pulse.
- \*8  $CM_H$  – The maximum tolerable rate of rise of the common mode voltage to ensure the output will remain in the HIGH state (i.e.,  $V_{OUT} > 2.0V$ ).
- \*9  $CM_L$  – The maximum tolerable rate of rise of the common mode voltage to ensure the output will remain in the LOW output state (i.e.,  $V_{OUT} < 0.8V$ ).

**Order Information**

**Part Number**

**EL063X(Z)-V**

**Note**

- X = Part no. (X = 0 or 1)
- Z = Tape and reel option (TA, TB or none).
- V = VDE (optional)

Option	Description	Packing quantity
None	Standard	100 units per tube
-V	Standard + VDE	100 units per tube
(TA)	TA tape & reel option	2000 units per reel
(TB)	TB tape & reel option	2000 units per reel
(TA)-V	TA tape & reel option + VDE	2000 units per reel
(TB)-V	TB tape & reel option + VDE	2000 units per reel



**Package Dimension**  
(Dimensions in mm)

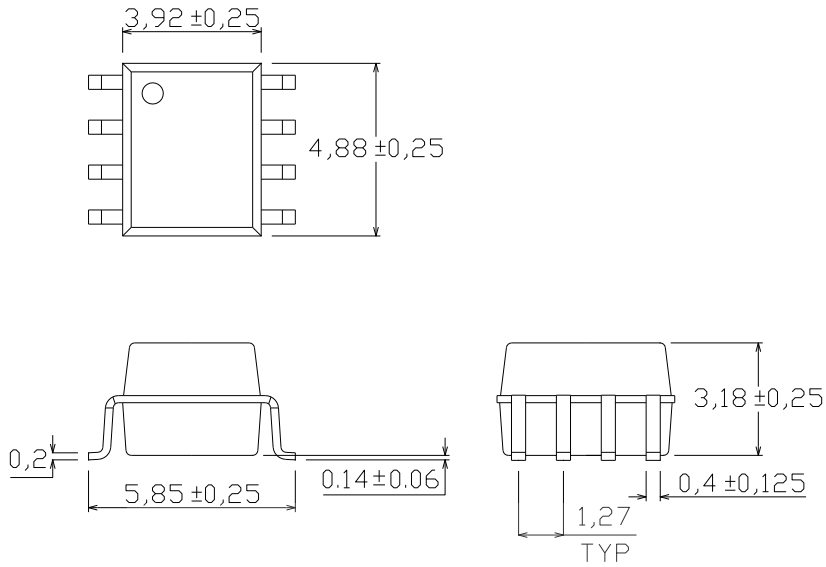

**Recommended pad layout for surface mount leadform**

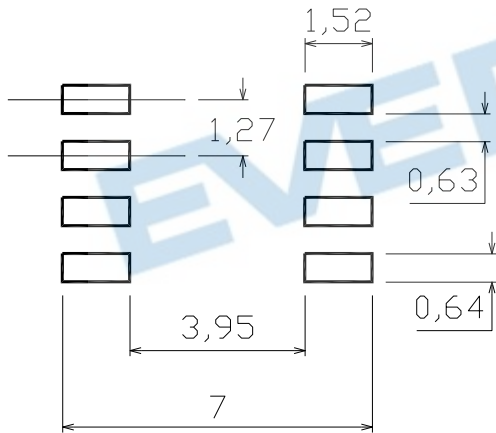

## Device Marking

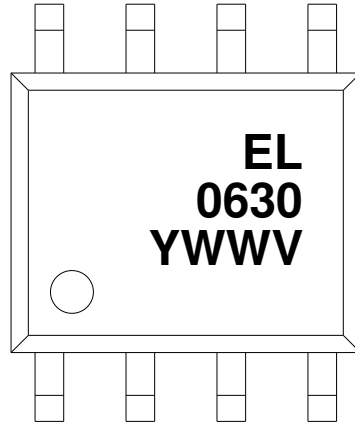

## Notes

0630	denotes Device Number
Y	denotes 1 digit Year code
WW	denotes 2 digit Week code
V	denotes VDE (optional)

EVERLIGHT

Tape & Reel Packing Specifications

Option TA

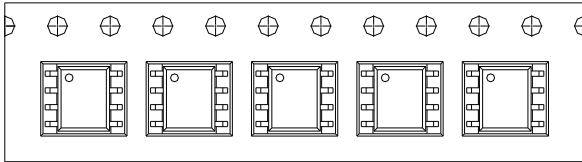

Option TB

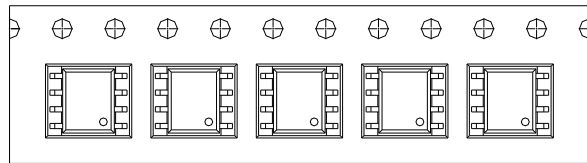

Direction of feed from reel



Direction of feed from reel

Tape dimensions

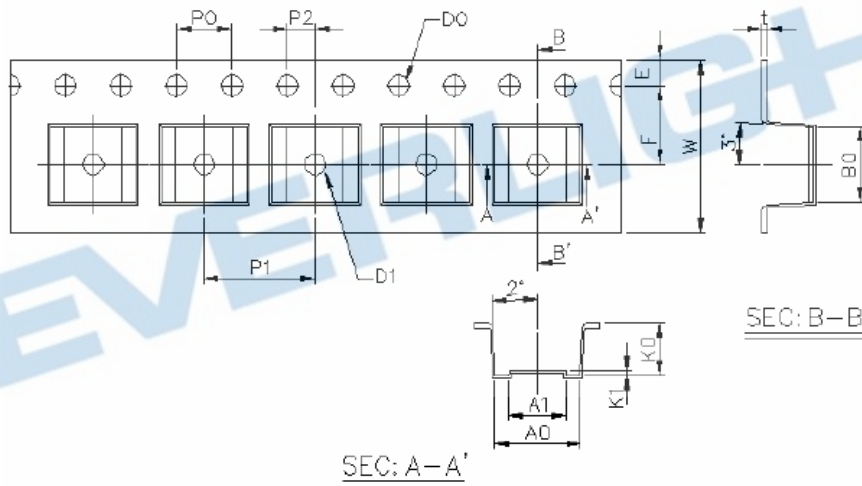

Dimension No.	<b>A0</b>	<b>A1</b>	<b>B0</b>	<b>D0</b>	<b>D1</b>	<b>E</b>	<b>F</b>
Dimension(mm)	6.2±0.1	4.1±0.1	5.28±0.1	1.5±0.1	1.5±0.3	1.75±0.1	5.5±0.1
Dimension No.	<b>Po</b>	<b>P1</b>	<b>P2</b>	<b>t</b>	<b>W</b>	<b>K0</b>	<b>K1</b>
Dimension(mm)	4.0±0.1	8.0±0.1	2.0±0.1	0.4±0.1	12.0+0.3/ -0.1	3.7±0.1	0.3±0.1

**Precautions for Use**

1. Soldering Condition

1.1 (A) Maximum Body Case Temperature Profile for evaluation of Reflow Profile

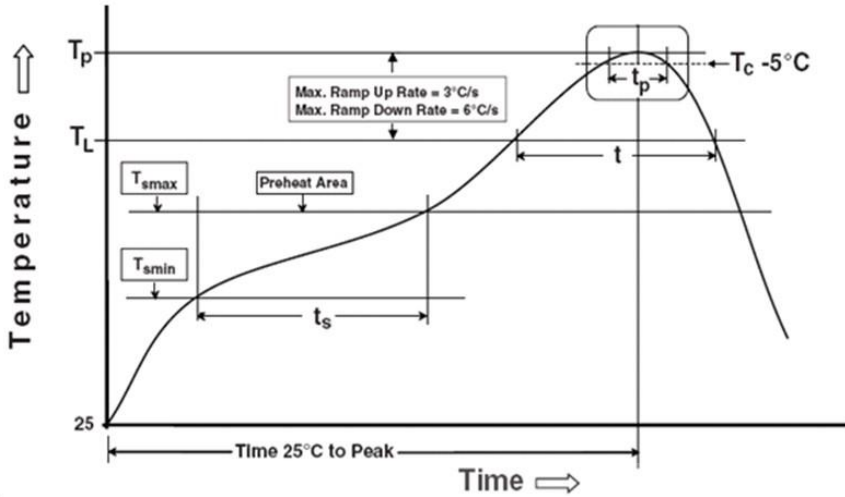

Note:

Reference: IPC/JEDEC J-STD-020D

**Preheat**

Temperature min ( $T_{smin}$ )	150 °C
Temperature max ( $T_{smax}$ )	200°C
Time ( $T_{smin}$ to $T_{smax}$ ) ( $t_s$ )	60-120 seconds
Average ramp-up rate ( $T_{smax}$ to $T_p$ )	3 °C/second max

**Other**

Liquidus Temperature ( $T_L$ )	217 °C
Time above Liquidus Temperature ( $t_L$ )	60-100 sec
Peak Temperature ( $T_p$ )	260°C
Time within 5 °C of Actual Peak Temperature: $T_p - 5°C$	30 s
Ramp- Down Rate from Peak Temperature	6°C /second max.
Time 25°C to peak temperature	8 minutes max.
Reflow times	3 times

## DISCLAIMER

1. Above specification may be changed without notice. EVERLIGHT will reserve authority on material change for above specification.
2. When using this product, please observe the absolute maximum ratings and the instructions for using outlined in these specification sheets. EVERLIGHT assumes no responsibility for any damage resulting from use of the product which does not comply with the absolute maximum ratings and the instructions included in these specification sheets.
3. These specification sheets include materials protected under copyright of EVERLIGHT Corporation. Please don't reproduce or cause anyone to reproduce them without EVERLIGHT's consent.

EVERLIGHT