



BAT54TB-AU~BAT54STB-AU

SCHOTTKY BARRIER RECTIFIER

Voltage 30 V **Current** 0.2 A

Features

- Low forward voltage drop
- Deal for automated placement
- Low power loss, high efficiency
- High surge current capability
- AEC-Q101 qualified
- Lead free in compliance with EU RoHS 2.0
- Green molding compound as per IEC 61249 standard

Mechanical Data

- Case : SOT-523 Package
- Terminals : Solderable per MIL-STD-750, Method 2026
- Approx. Weight : 0.002 grams

SOT-523

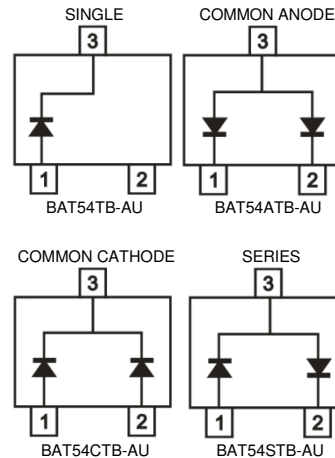

Maximum Ratings and Thermal Characteristics (T_A = 25°C unless otherwise noted)

PARAMETER	SYMBOL	LIMIT	UNITS
Maximum Repetitive Peak Reverse Voltage	V _{RRM}	30	V
Maximum RMS Voltage	V _{RMS}	21	V
Maximum DC Blocking Voltage	V _{DC}	30	V
Maximum Average Forward Current	I _{F(AV)}	0.2	A
Peak Forward Surge Current : 1 s Single Half Sine-Wave Superimposed On Rated Load	I _{FSM}	0.6	A
Typical Junction Capacitance Measured at 1 MHZ And Applied V _R = 4 V	C _J	4	pF
Typical Thermal Resistance	R _{θJA} ⁽¹⁾	630	°C/W
Operating Junction Temperature Range	T _J	-55~125	°C
Storage Temperature Range	T _{STG}	-55~125	°C



BAT54TB-AU~BAT54STB-AU

Electrical Characteristics ($T_A = 25^\circ\text{C}$ unless otherwise noted)

PARAMETER	SYMBOL	TEST CONDITION	MIN.	TYP.	MAX.	UNITS
Forward Voltage	V_F	$I_F = 1 \text{ mA}, T_J = 25^\circ\text{C}$	-	-	0.32	V
		$I_F = 100 \text{ mA}, T_J = 25^\circ\text{C}$	-	-	0.6	
		$I_F = 1 \text{ mA}, T_J = 100^\circ\text{C}$	-	0.17	-	
		$I_F = 100 \text{ mA}, T_J = 100^\circ\text{C}$	-	0.48	-	
Reverse Current	$I_R^{(2)}$	$V_R = 24 \text{ V}, T_J = 25^\circ\text{C}$	-	0.1	-	uA
		$V_R = 30 \text{ V}, T_J = 25^\circ\text{C}$	-	-	2	
		$V_R = 30 \text{ V}, T_J = 100^\circ\text{C}$	-	27	-	

NOTES :

1. Mounted on a FR4 PCB, single-sided copper, mini pad.
2. Short duration pulse test used to minimize self-heating effect.



BAT54TB-AU~BAT54STB-AU

TYPICAL CHARACTERISTIC CURVES

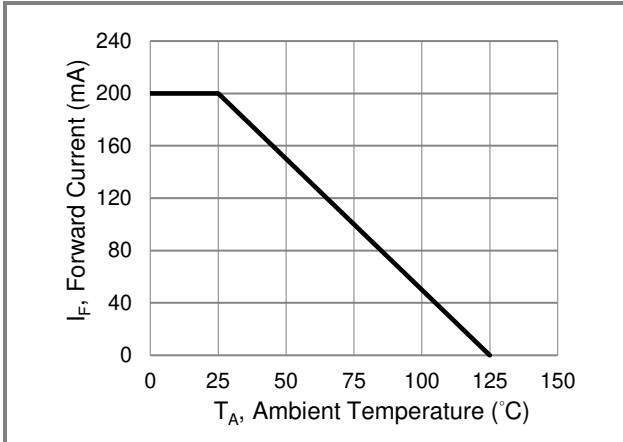

Fig.1 Forward Current Derating Curve

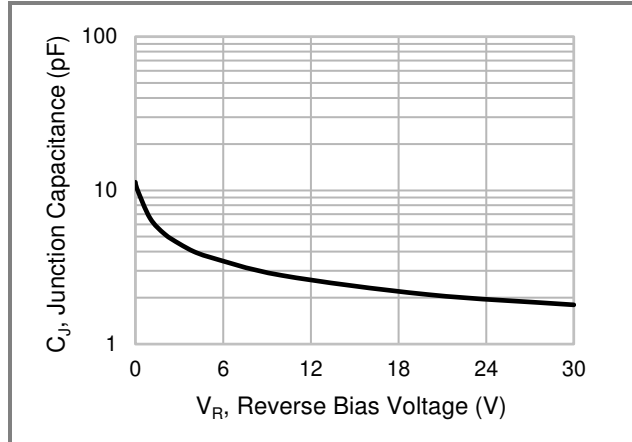

Fig.2 Typical Junction Capacitance

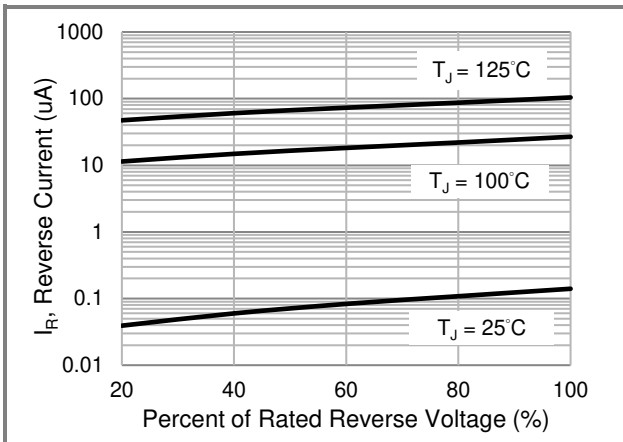

Fig.3 Typical Reverse Characteristics

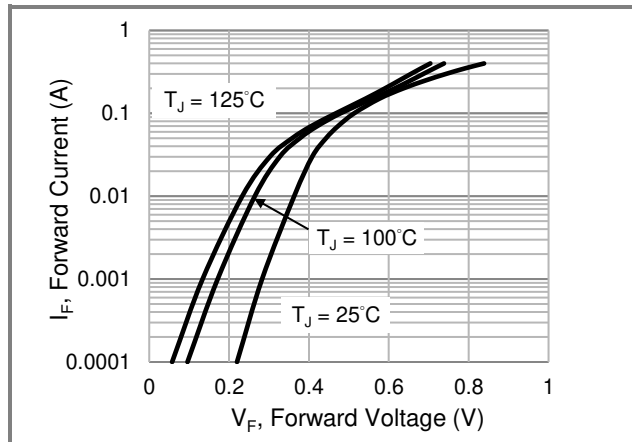

Fig.4 Typical Forward Characteristics

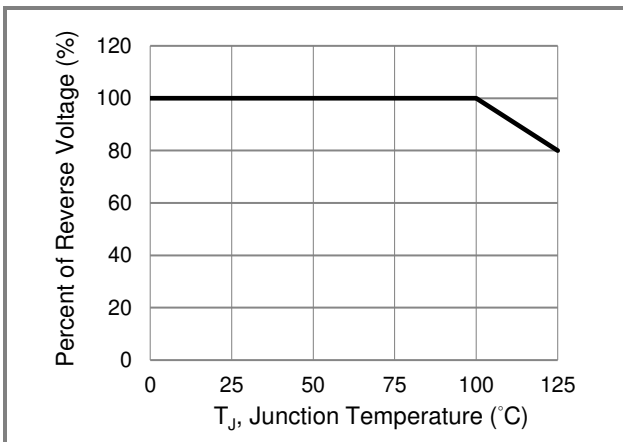

Fig.5 Operating Temperature Derating Curve



BAT54TB-AU~BAT54STB-AU

Part No. Packing Code Version

Part No. Packing Code	Package Type	Packing Type	Marking	Version
BAT54TB-AU_R1_000A1	SOT-523	4K / 7" Reel	LV	Halogen free RoHS compliant
BAT54ATB-AU_R1_000A1	SOT-523	4K / 7" Reel	LW	Halogen free RoHS compliant
BAT54CTB-AU_R1_000A1	SOT-523	4K / 7" Reel	LX	Halogen free RoHS compliant
BAT54STB-AU_R1_000A1	SOT-523	4K / 7" Reel	LY	Halogen free RoHS compliant

Packaging Information & Mounting Pad Layout

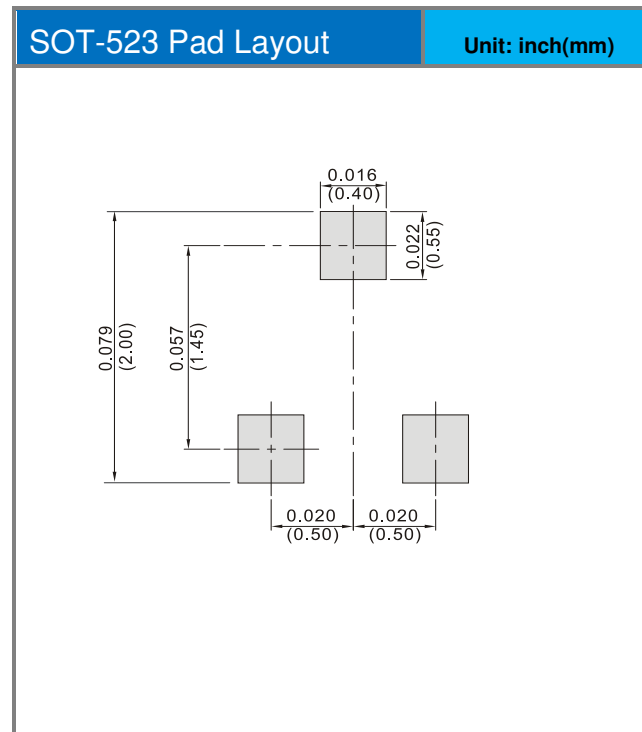
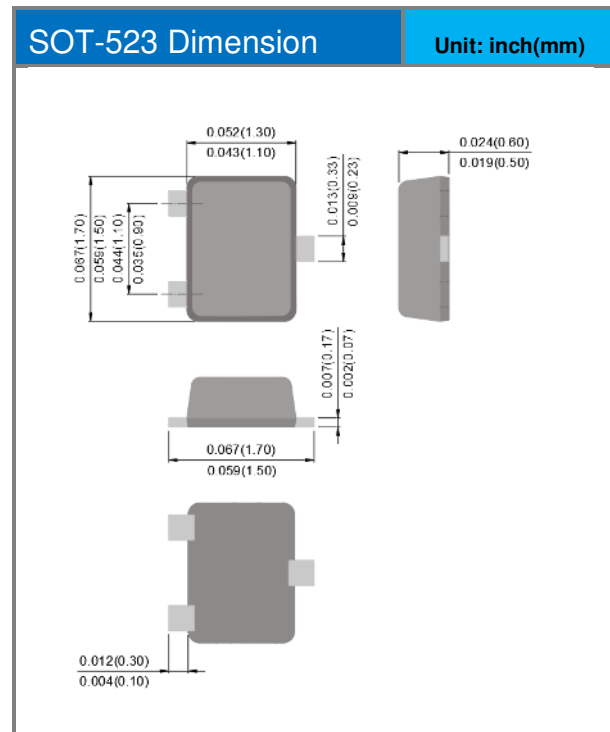



BAT54TB-AU~BAT54STB-AU

Disclaimer

- Reproducing and modifying information of the document is prohibited without permission from Panjit International Inc..
- Panjit International Inc. reserves the rights to make changes of the content herein the document anytime without notification. Please refer to our website for the latest document.
- Panjit International Inc. disclaims any and all liability arising out of the application or use of any product including damages incidentally and consequentially occurred.
- Panjit International Inc. does not assume any and all implied warranties, including warranties of fitness for particular purpose, non-infringement and merchantability.
- Applications shown on the herein document are examples of standard use and operation. Customers are responsible in comprehending the suitable use in particular applications. Panjit International Inc. makes no representation or warranty that such applications will be suitable for the specified use without further testing or modification.
- The products shown herein are not designed and authorized for equipments relating to human life and for any applications concerning life-saving or life-sustaining, such as medical instruments, aerospace machinery et cetera. Customers using or selling these products for use in such applications do so at their own risk and agree to fully indemnify Panjit International Inc. for any damages resulting from such improper use or sale.
- Since Panjit uses lot number as the tracking base, please provide the lot number for tracking when complaining.