

15492.2 ZPRC 6-12-24V AC/DC



Plug-Relay-Compact (PRC) socket base PRC with tension-spring connection, Mounting type: Mounting rail TS 35, 1 CO contact, Input voltage: 6, 12 or 24 VAC/DC

Business data

Article number	<u>15492.2</u>
Article name	ZPRC 6-12-24V AC/DC
GTIN (EAN)	4044211118297
Packaging unit	10
Quantity unit	PC
Weight per piece (not including packaging)	30.2 g
Weight per piece (including packaging)	32.27 g
Unit of weight	G
Customs number	85369010
Country of origin	IT
Product description	Relay socket base with tension-spring connection

Technical data

Dimensions

Length	93 mm
Width	6.2 mm
Height TS 35 / 7.5 with BA	79.9 mm

Ratings

Rated voltage Un	6-12-24 VAC/DC -
Overvoltage category	III
Contamination degree	3

Connection data

Connection principle	Tension-spring connection
Wire cross-section single core (rigid), min.	0.2 mm ²
Wire cross-section single-core (rigid), max.	2.5 mm ²
Wire cross-section stranded, min.	0.2 mm ²
Wire cross-section stranded, max.	2.5 mm ²
Stripping length	10 mm

Output data

Switching voltage / switching voltage max.	250 / 400 VAC
Contact configuration	1 CO contact

Materials

Working temperature, min.	-40 °C
Working temperature, max.	70 °C

Further technical data

Degree of protection	IP20
Status display	✓

Environmental Product Compliance

REACH Conform	yes
REACH Reference date	2023-06-14
REACH Candidate Substance Note	No
RoHS Conform	yes

Approvals

Standards and regulations

CE compliant	yes
cUL approval	CSA-C22.2 No. 14
UL approval	UL 508
UL Recognized	1
cUL Recognized	1

Media

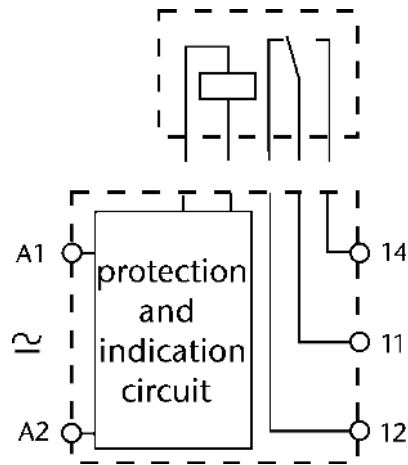
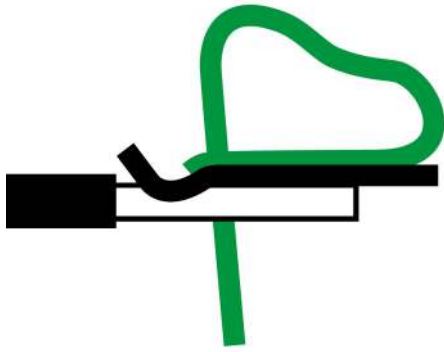

15492.2 ZPRC 6-12-24V AC/DC

Accessories

Cross-connector



External cross-connector insulated for Plug-Relay-Compact (PRC), 20-pole, can be shortened, Voltage: 250 V, Current: 36 A

Article number	Article name	GTIN (EAN)	Packaging unit
<u>15545.8</u>	AQI/PRC/20 YE	4044211118440	1

Quick marking

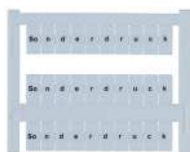

Terminal marker / Pocket Maxicard, Length: 12 mm, Width: 6 mm, Colour: White

Article number	Article name	GTIN (EAN)	Packaging unit
<u>9107.7</u>	PMC BSTR 6/30 So WH	4044211099749	300 ST



Terminal marker / Pocket Maxicard, Length: 12 mm, Width: 6 mm, Colour: White

Article number	Article name	GTIN (EAN)	Packaging unit
<u>9106.7</u>	PMC BSTR 6/30 WH	4044211099732	300 ST

Partition plate



Partition plate for Plug-Relay-Compact (PRC) for separating relay blocks, width: 1.5 mm

Article number	Article name	GTIN (EAN)	Packaging unit
<u>15546.2</u>	TW/PRC GR	4044211118457	1 ST

Relays



Plug-in miniature power relay, With multi-layer gold contact, 1 CO contact, Input voltage: 12 VDC

Article number	Article name	GTIN (EAN)	Packaging unit
<u>15558.2</u>	PRC 1/12V DC Au	4044211118389	10 ST

15492.2 ZPRC 6-12-24V AC/DC

Relays



Plug-in miniature power relay, With multi-layer gold contact, 1 CO contact, Input voltage: 24 VDC

Article number	Article name	GTIN (EAN)	Packaging unit
<u>15559.2</u>	PRC 1/24V DC Au	4044211118396	10 ST



Plug-in miniature power relay, With power contact, 1 CO contact, Input voltage: 5 VDC

Article number	Article name	GTIN (EAN)	Packaging unit
<u>15500.2</u>	PRC 1/5V DC	4044211118174	10 ST



Plug-in miniature power relay, With power contact, 1 CO contact, Input voltage: 12 VDC

Article number	Article name	GTIN (EAN)	Packaging unit
<u>15501.2</u>	PRC 1/12V DC	4044211118136	10 ST



Plug-in miniature power relay, With power contact, 1 CO contact, Input voltage: 24 VDC

Article number	Article name	GTIN (EAN)	Packaging unit
<u>15502.2</u>	PRC 1/24V DC	4044211118143	10 ST



Plug-in miniature power relay, With multi-layer gold contact, 1 CO contact, Input voltage: 5 VDC

Article number	Article name	GTIN (EAN)	Packaging unit
<u>15557.2</u>	PRC 1/5V DC Au	4044211118372	10 ST